

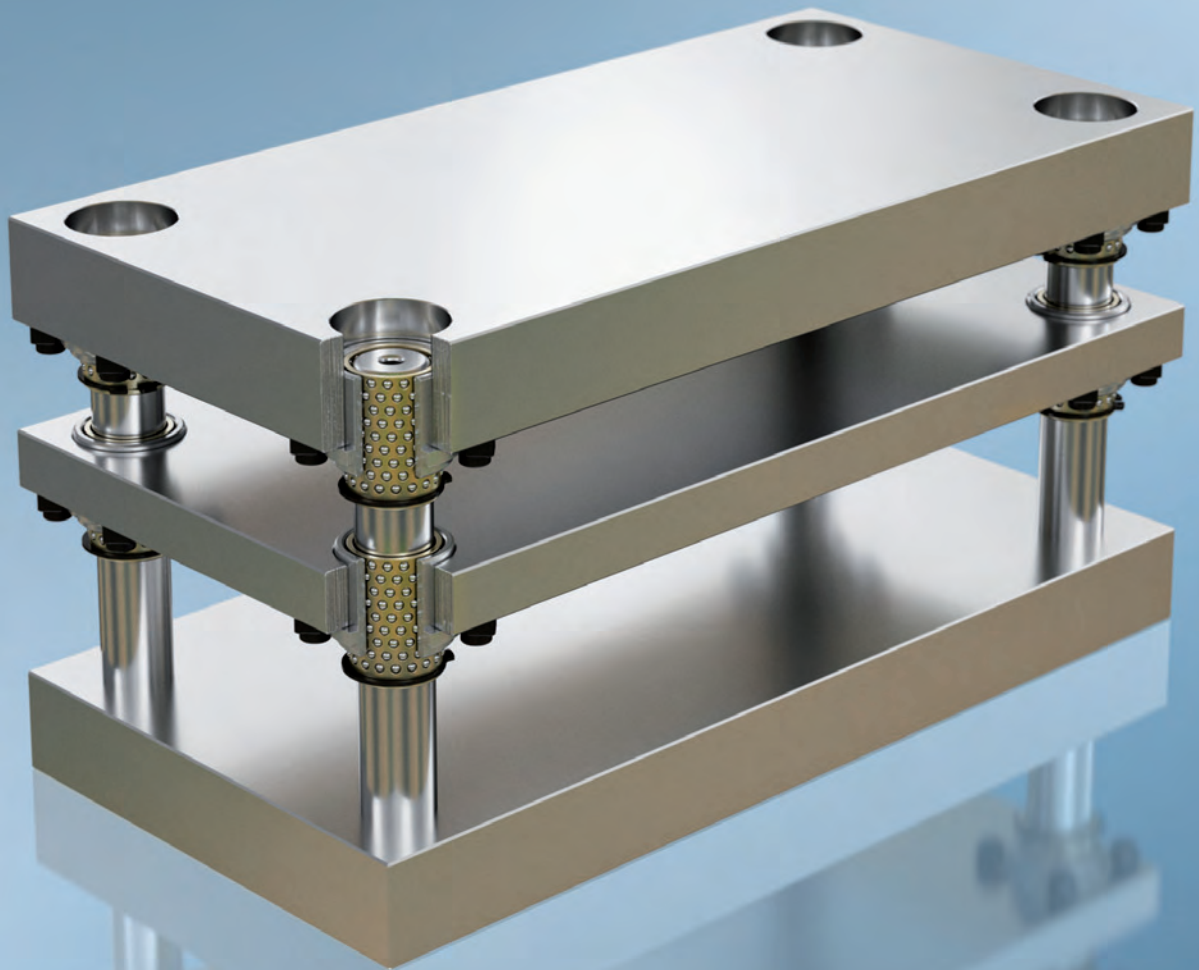









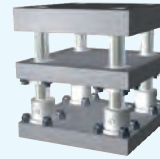

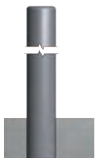
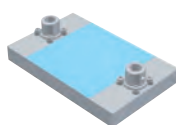
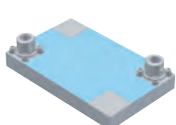
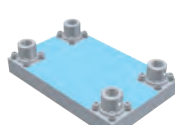
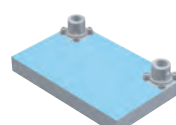
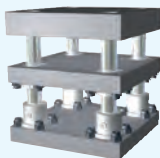
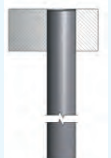
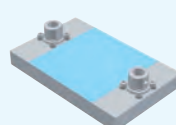
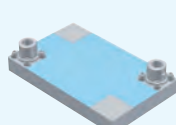
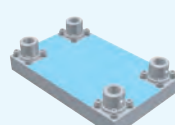
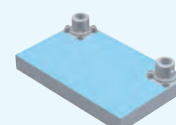
**STRACK**<sup>®</sup>  
NORMALIEN

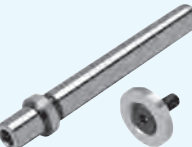

COMBI-SÄULENGESTELLE  
COMBI-DIE SETS  
COMBI-BLOCS A COLONNES

					
					
					
					
					
					
					
					
					
					
<p>Führungselemente/ Guide elements/Éléments de guidage</p>			<p>Führungselemente/ Guide elements/Éléments de guidage</p>		
<p>4.58</p>			<p>4.60</p>		
					
<p>Führungselemente/ Guide elements/Éléments de guidage</p>			<p>Führungselemente/ Guide elements/Éléments de guidage</p>		
<p>4.62</p>			<p>4.64</p>		
					
<p>Führungselemente/ Guide elements/Éléments de guidage</p>			<p>Führungselemente/ Guide elements/Éléments de guidage</p>		
<p>4.66</p>			<p>4.68</p>		
					
<p>deutsch</p>		<p>english</p>		<p>français</p>	
<p>4.74</p>		<p>4.76</p>		<p>4.78</p>	

Einheitsbohrungen

Basic holes

Alésages identiques

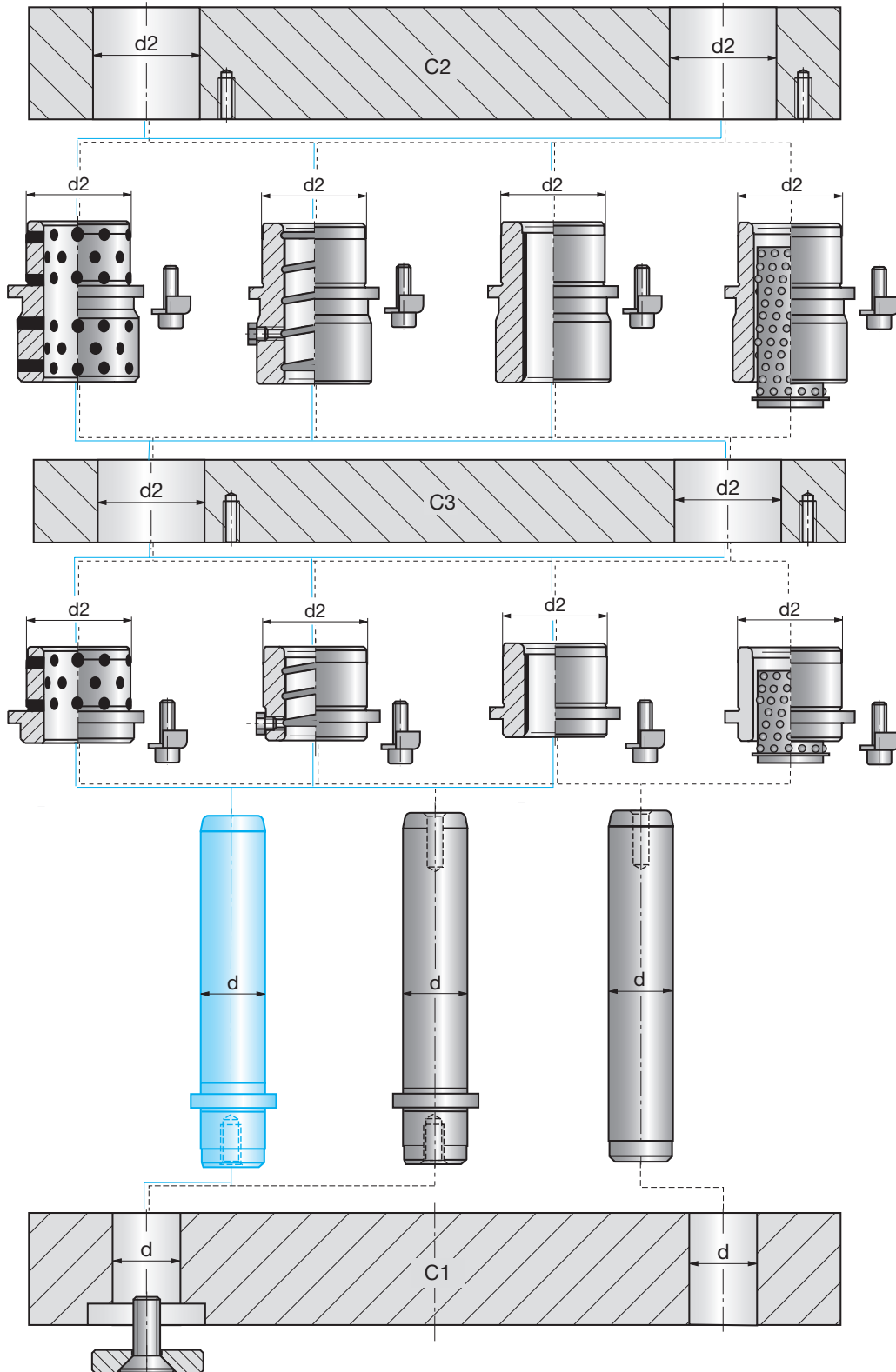

Einheitsbohrungen

Basic holes

Alésages identiques

4

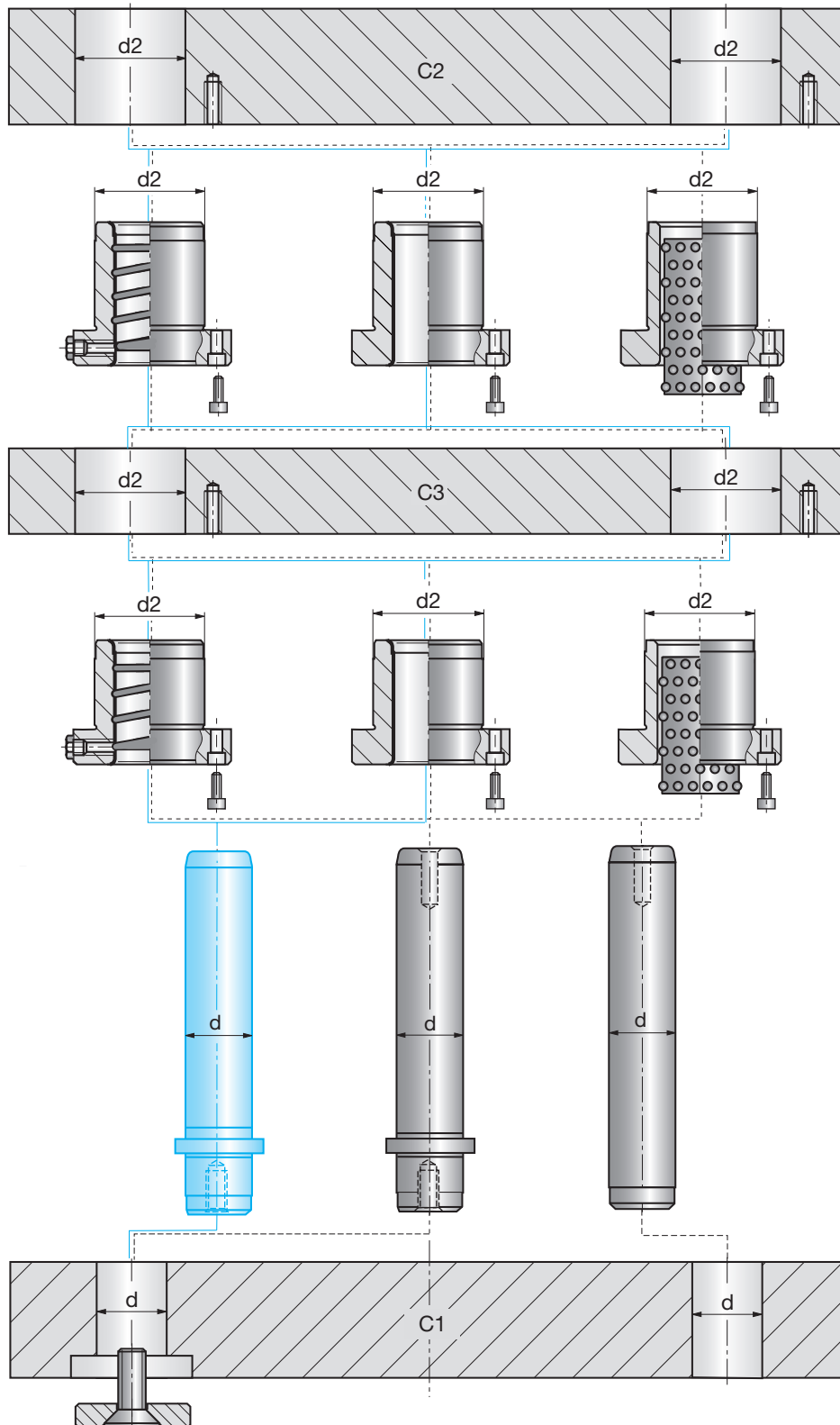

**Combi-Säulengestelle**

**Combi-die sets**

**Combi-blocs à colonnes**

**Größenübersicht**

**Size overview**

**Ensemble des dimensions**

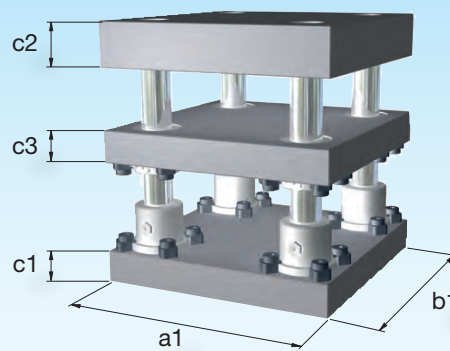
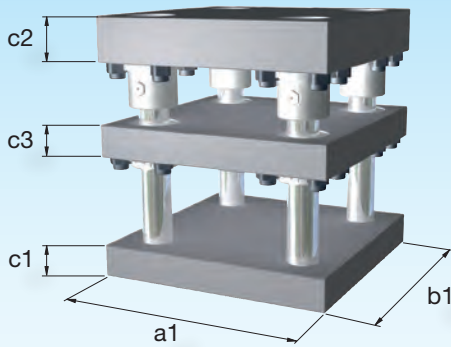

4

b1	a1	C1					C2					C3		
		27	37	47	57	67	27	37	47	57	67	27	37	
156	156	x	x				x	x				x		
	196	x	x				x	x				x		
	246	x	x				x	x				x		
	311	x	x				x	x				x		
196	196	x	x				x	x				x		
	246	x	x				x	x				x		
	311	x	x				x	x				x		
	396	x	x				x	x				x		
	496	x	x	x			x	x	x			x		
246	246		x	x				x	x			x		
	311		x	x				x	x			x		
	396		x	x				x	x			x		
	496		x	x				x	x			x		
	626			x	x				x	x		x		
	706			x	x				x	x		x		
311	311		x	x				x	x			x		
	396		x	x				x	x			x		
	496			x	x				x	x		x		
	626			x	x				x	x		x		
	706			x	x				x	x		x		
	796			x	x				x	x		x		
396	396			x	x				x	x			x	
	496			x	x				x	x			x	
	626				x	x				x	x		x	
	706				x	x				x	x		x	
	796				x	x				x	x		x	
496	496				x	x					x	x		x
	626				x	x					x	x		x
	706				x	x					x	x		x
	796				x	x					x	x		x
626	626				x	x					x	x		x
	706				x	x					x	x		x
	796				x	x					x	x		x

**Combi-Säulengestelle**

**Combi-die sets**

**Combi-blocs à colonnes**

**Auswahlhilfe**

**Selection guide**

**Guide desélection**

4







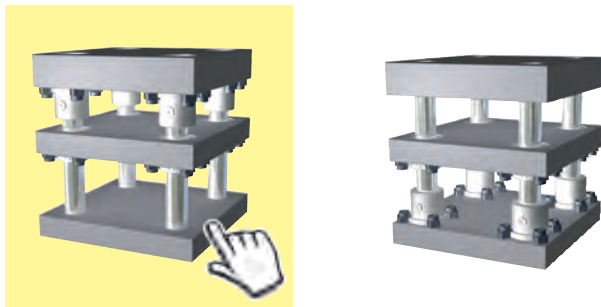



















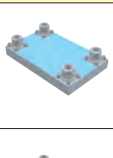

Beispielstückliste / Example part list /  
Liste des pièces des exemples

	Artikelbezeichnung / Article / Désignation de l'article	Stck	
1.1	SG-65-C1-246-196-37-1.1730	1	Gestellplatte / Die set plate / Plaque de bloc à colonnes
1.2	SG-6-C2-246-196-37-1.1730	1	Gestellplatte / Die set plate / Plaque de bloc à colonnes
1.3	SN1769-24-40-B	1	Führungsbuchse / Guide bush / Bague de guidage
1.4	SN1769-25-40-B	1	Führungsbuchse / Guide bush / Bague de guidage
1.5	SN4321-24-200	1	Führungssäule / Guide pillar / Colonne de guidage
1.6	SN4321-25-200	1	Führungssäule / Guide pillar / Colonne de guidage
1.7	SN3500-M5-16	8	Zylinderschraube / Cylinder screws / Vis 6 pans creux
1.8	SN1707-32-8	2	Haltscheibe / Retaining ring / Rodelle de fixation

1.



2.

Combi Säulengestelle mit unten stehenden Säulen		Combi-die sets with down-mounted columns				Combi-blocs à colonnes avec colonnes montées en bas			
Arbeitsflächen Working surfaces Plans de travail		Befestigungsart der Führungselemente Mounting type of the guide elements		Type de montage des éléments de guidage					
									
	Seite / Page 4.10	Seite / Page 4.11	Seite / Page 4.12	Seite / Page 4.13	Seite / Page 4.14	Seite / Page 4.15	Seite / Page 4.16	Seite / Page 4.17	Seite / Page 4.18
							Seite / Page 4.19	Seite / Page 4.20	Seite / Page 4.21
	Seite / Page 4.10	Seite / Page 4.11	Seite / Page 4.12	Seite / Page 4.13	Seite / Page 4.14	Seite / Page 4.15	Seite / Page 4.16	Seite / Page 4.17	Seite / Page 4.18
							Seite / Page 4.19	Seite / Page 4.20	Seite / Page 4.21
	Seite / Page 4.22	Seite / Page 4.23	Seite / Page 4.24	Seite / Page 4.25	Seite / Page 4.26	Seite / Page 4.27	Seite / Page 4.28	Seite / Page 4.29	Seite / Page 4.30
							Seite / Page 4.28	Seite / Page 4.29	Seite / Page 4.30
	Seite / Page 4.22	Seite / Page 4.23	Seite / Page 4.24	Seite / Page 4.25	Seite / Page 4.26	Seite / Page 4.27	Seite / Page 4.28	Seite / Page 4.29	Seite / Page 4.30

Kombinieren Sie in 4 Schritten aus einer großen Anzahl von STRACK Führungselementen und Gestellplatten Ihr individuelles Säulengestell.

Im 1. Schritt bestimmen Sie, ob die Säulen in der Grund- oder Kopfplatte montiert werden sollen. (Seiten 8 und 9)  
Im 2. Schritt definieren Sie die Art der Arbeitsfläche, die Anzahl der Gestellplatten, den Typ der Führungselemente und deren Befestigungsart.

Weiter auf der sich durch Ihre Auswahl ergebenen Seite. Im 3. Schritt legen Sie die Plattenabmaße und somit die resultierenden Parameter, wie z.B. die Größe der Arbeitsfläche und die Führungsdurchmesser fest.

Die Seitenangabe unter der Abbildung der Führungselemente leitet Sie zu den passenden Führungselementen.

Im 4. Schritt definieren Sie die sich durch Ihre Auswahl ergebenden Führungselemente.

Combine your individual die set in four steps out of a great number of STRACK guide elements and die set plates. In the first step determine whether the columns should be mounted in the base plate or the top plate (pages 8 and 9). In the second step define the kind of the work surface, the number of the die set plates, the type of the guide elements and their mounting type.

Continue with the page resulting from your selection. In the third step you determine the plate dimensions and thus the resulting parameters, like for example the size of the working surface and the guide diameter.

The page reference under the illustration "guide elements" will lead you to the suitable guide elements. In the fourth step you define the guide elements resulting from your selection.

Combinez votre bloc à colonne individuel en quatre pas du grand nombre des STRACK éléments de guidages et des plaques de bloc à colonnes.

Dans un premier pas déterminez si les colonnes doivent être montées dans la plaque de base ou la plaque de tête.

Dans un deuxième pas définissez la mode du plan de travail, le nombre des plaques de bloc à colonnes, le type des éléments de guidage et leur type de montage.

Continuez avec la page résultante de votre sélection.

Dans un troisième pas vous déterminez les dimensions des plaques et par conséquent les paramètres résultants, par exemple la grandeur du plan de travail et le diamètre de guidage.

L'indication de la page sous l'image "éléments de guidage" vous amène aux éléments de guidage appropriés.

Dans un quatrième pas vous définissez les éléments de guidage résultants de votre sélection.

**Combi-Säulengestelle**

**Combi-die sets**

**Combi-blocs à colonnes**

**Auswahlhilfe**

**Selection guide**

**Guide désélection**

**3.**

**Combi Säulengestelle mit unten stehenden Säulen**

**Combi die sets with down-mounted columns**

**Combi blocs à colonnes avec colonnes montées en bas**

**Auswahl Gestellplatten**

**Selection die set plates**

**Sélection des plaques de bloc à colonnes**

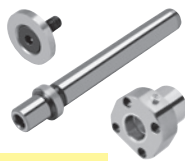

siehe Seite  
see page 4.40  
voir page

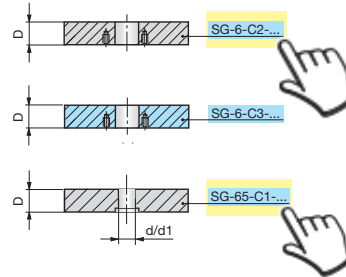
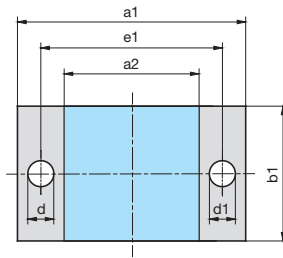

SG-65-C1-  
a1-b1-D-Mat Mat.: 1.1730/C45W

SG	b1	a1	C1 D	C2 D	C3 D	a2	e1	Ød	Ød1
SG-65-C1/ SG-6-C2/ SG-6-C3	156	156	37	37	27	58	100	19	20
		196	37	37	27	98	140	19	20
		246	37	37	27	148	190	19	20
	196	311	37	37	27	213	255	19	20
		196	37	37	27	84	132	24	25
		246	37	37	27	134	182	24	25
		311	37	37	27	199	247	24	25
		396	37	37	27	284	332	24	25

**4.**

**Führungssäulen mit Bund und Haltescheiben**

**Guide pillars with collar and retaining plates**

**Colonnes de guidage avec épaulement et rondelles de fixation**

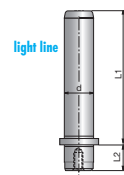
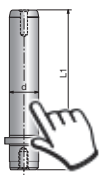

SN 4321- Mat.: 1.0503/63+2HRC  
DIN 9825-4/ISO 9182-5  
SN 4321-d-L1

SN 4322- Mat.: 1.0503/63+2HRC  
DIN 9825-4/ISO 9182-5  
SN 4322-d-L1

d	L1	L2	d	L1	L2	d	L1	L2	d	L1	L2	d	L1	L2
19/20	100	23	24/25	100	30	30/32	112	37	38/40	125	37	48/50	140	47
	112	23		112	30		125	37		140	37		160	47
	125	23		125	30		140	37		160	37		180	47
	140	23		140	30		160	37		180	37		200	47
	160	23		160	30		180	37		200	37		224	47
	180	23		180	30		200	37		224	37		250	47
	200	23		200	30		224	37		250	37		280	47
				224	30		250	37		280	37		315	47
				250	30		280	37		315	37		355	47
							315	37		355	37		400	47

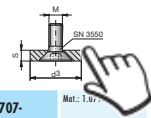

SN 1707- Mat.: 1.0717  
SN 1707-d3-M

d	M	d	S
25	M8	19/20	5,5
32	M8	24/25	5,5
40	M8	30/32	7,5
50	M8	38/40	9,5

**Führungsbuchsen mit Flansch**

**Guide bushes with flange**

**Bagues de guidage avec collerette**

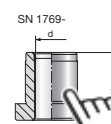
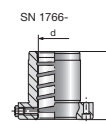

SN 1766- Mat.: 1.1740  
52+2HRC-CuSn12  
SN 1766-d-L4-T

SN 1769- Mat.: 1.1740  
52+2HRC-CuSn12  
SN 1769-d-L4-T

d	L4	d	L4	d	L4	d	L4	d	L4	T*
19/20	35	24/25	40	30/32	50	38/40	60	48/50	80	A/B/C
	50	60	75	85	100					A/B/C

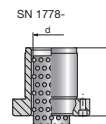

SN 1778- Mat.: 1.3505  
63+2HRC-CuZn40  
SN 1778-d-L4

d	L4	d	L4	d	L4	d	L4
19/20	38	24/25	40	30/32	47	38/40	56
	51	60	70	80	80	48/50	66



SN 3500- Mat.: 1.3505  
63+2HRC-CuZn40  
SN 3500-d-L1











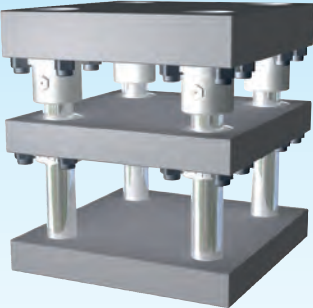



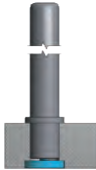
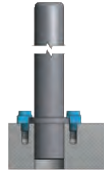
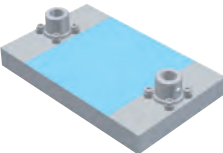

d	L	Ø	SN 1766 SN 1769	SN 1778	SN 1766 SN 1769	SN 1778
M4	12	19/20	35	30	M6	25
	16	24/25	40	40		38/40
	25	30/32	50	51		40
	30	38/40	60	60		48/50
	35	48/50	75	70		80
	40	60	85	80		100
	45	80	90	90		

**Combi-Säulengestelle  
mit unten stehenden Säulen**

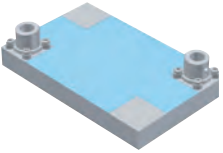
**Combi-die sets  
with down-mounted columns**

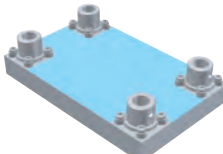
**Combi-blocs à colonnes  
avec colonnes montées en bas**

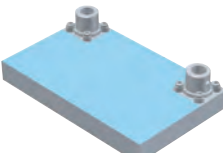
4











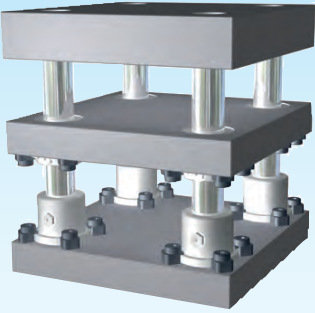









		Befestigungsart der Führungselemente		Mounting type of the guide elements		Type de montage des elements de guidage	
							
Arbeitsflächen Working surfaces Plans de travail		Anzahl der Platten Number of the plates Nombre des plaques					
		Seite / Page 4.10	Seite / Page 4.11	Seite / Page 4.12	Seite / Page 4.13	Seite / Page 4.14	Seite / Page 4.15
		Seite / Page 4.10	Seite / Page 4.11	Seite / Page 4.12	Seite / Page 4.13	Seite / Page 4.14	Seite / Page 4.15
		Seite / Page 4.16	Seite / Page 4.17	Seite / Page 4.18	Seite / Page 4.19	Seite / Page 4.20	Seite / Page 4.21
		Seite / Page 4.16	Seite / Page 4.17	Seite / Page 4.18	Seite / Page 4.19	Seite / Page 4.20	Seite / Page 4.21
		Seite / Page 4.22	Seite / Page 4.23	Seite / Page 4.24	Seite / Page 4.25	Seite / Page 4.26	Seite / Page 4.27
		Seite / Page 4.22	Seite / Page 4.23	Seite / Page 4.24	Seite / Page 4.25	Seite / Page 4.26	Seite / Page 4.27
		Seite / Page 4.28	Seite / Page 4.29	Seite / Page 4.30	Seite / Page 4.31	Seite / Page 4.32	Seite / Page 4.33

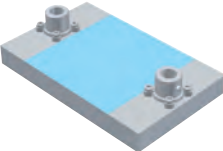

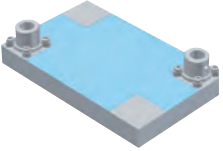
**Combi-Säulengestelle  
mit oben hängenden Säulen**

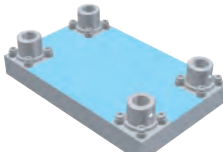
**Combi-die sets  
with aerial-mounted columns**

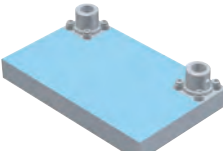
**Combi-blocs à colonnes  
avec colonnes montées en haut**

		Befestigungsart der Führungselemente		Mounting type of the guide elements		Type de montage des elements de guidage	
							
Arbeitsflächen Working surfaces Plans de travail	Anzahl der Platten Number of the plates Nombre des plaques						
		Seite / Page 4.34	Seite / Page 4.35	Seite / Page 4.36	Seite / Page 4.37	Seite / Page 4.38	Seite / Page 4.39
		Seite / Page 4.34	Seite / Page 4.35	Seite / Page 4.36	Seite / Page 4.37	Seite / Page 4.38	Seite / Page 4.39
		Seite / Page 4.40	Seite / Page 4.41	Seite / Page 4.42	Seite / Page 4.43	Seite / Page 4.44	Seite / Page 4.45
		Seite / Page 4.40	Seite / Page 4.41	Seite / Page 4.42	Seite / Page 4.43	Seite / Page 4.44	Seite / Page 4.45
		Seite / Page 4.46	Seite / Page 4.47	Seite / Page 4.48	Seite / Page 4.49	Seite / Page 4.50	Seite / Page 4.51
		Seite / Page 4.46	Seite / Page 4.47	Seite / Page 4.48	Seite / Page 4.49	Seite / Page 4.50	Seite / Page 4.51
		Seite / Page 4.52	Seite / Page 4.53	Seite / Page 4.54	Seite / Page 4.55	Seite / Page 4.56	Seite / Page 4.57

**Combi-Säulengestelle  
mit unten stehenden Säulen**

**Combi-die sets  
with down-mounted columns**

**Combi-blocs à colonnes  
avec colonnes montées en bas**

**Auswahl Gestellplatten**

**Selection die set plates**

**Sélection des plaques de bloc à colonnes**



siehe Seite  
see page 4.58  
voir page

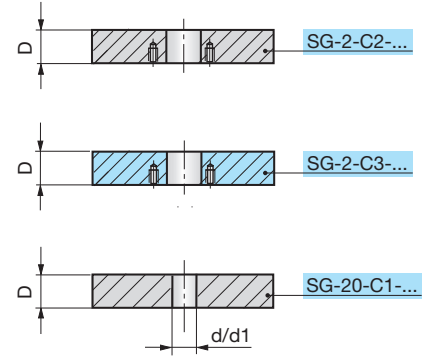
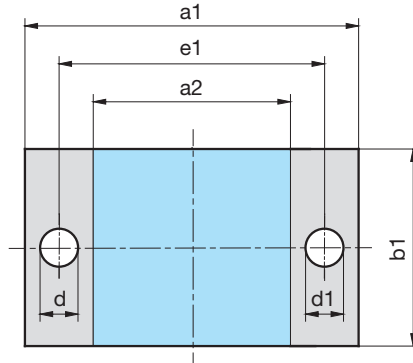

4



SG-20-C1-  
b1-a1-D-Mat

Mat.: 1.1730/C45W

Mat.: 3.4365 (AL)  
auf Anfrage / on request / sur demande

SG	b1	a1	C1 D	C2 D	C3 D	a2	e1	Ød	Ød1
SG-20-C1/ SG-2-C2/ SG-2-C3	156	156	27 / 37	27 / 37	27	48	100	19	20
		196	27 / 37	27 / 37	27	88	140	19	20
		246	27 / 37	27 / 37	27	138	190	19	20
		311	27 / 37	27 / 37	27	203	255	19	20
	196	196	27 / 37	27 / 37	27	74	132	24	25
		246	27 / 37	27 / 37	27	124	182	24	25
		311	27 / 37	27 / 37	27	189	247	24	25
		396	27 / 37	27 / 37	27	274	332	24	25
		496	37 / 47	37 / 47	27	360	424	30	32
	246	626	37 / 47	37 / 47	27	490	554	30	32
		246	37 / 47	37 / 47	27	110	174	30	32
		311	37 / 47	37 / 47	27	175	239	30	32
		396	37 / 47	37 / 47	27	260	324	30	32
		496	37 / 47	37 / 47	27	360	424	30	32
		626	47 / 57	47 / 57	27	470	542	38	40
	311	706	47 / 57	47 / 57	27	550	622	38	40
		311	37 / 47	37 / 47	27	175	239	30	32
		396	37 / 47	37 / 47	27	260	324	30	32
		496	47 / 57	47 / 57	27	340	412	38	40
		626	47 / 57	47 / 57	27	470	542	38	40
		706	47 / 57	47 / 57	27	550	622	38	40
	396	796	47 / 57	47 / 57	27	640	712	38	40
		396	47 / 57	47 / 57	37	240	312	38	40
		496	47 / 57	47 / 57	37	340	412	38	40
626		57 / 67	57 / 67	37	448	530	48	50	
706		57 / 67	57 / 67	37	528	610	48	50	
496	796	57 / 67	57 / 67	37	618	700	48	50	
	496	57 / 67	57 / 67	37	318	400	48	50	
	626	57 / 67	57 / 67	37	448	530	48	50	
	706	57 / 67	57 / 67	37	528	610	48	50	
626	796	57 / 67	57 / 67	37	618	700	48	50	
	626	57 / 67	57 / 67	37	448	530	48	50	
	706	57 / 67	57 / 67	37	528	610	48	50	

**Combi-Säulengestelle  
mit unten stehenden Säulen**

**Combi-die sets  
with down-mounted columns**

**Combi-blocs à colonnes  
avec colonnes montées en bas**

**Auswahl Gestellplatten**

**Selection die set plates**

**Sélection des plaques de bloc à colonnes**



siehe Seite  
see page **4.60**  
voir page

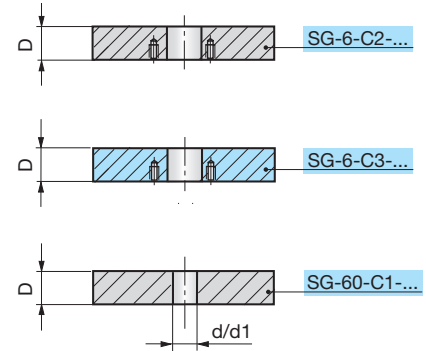
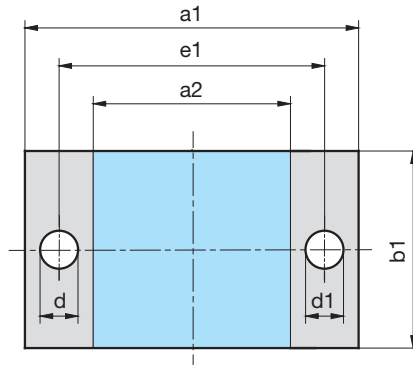

SG-60-C1-  
b1-a1-D-Mat

Mat.: 1.1730/C45W

Mat.: 3.4365 (AL)  
auf Anfrage / on request / sur demande

SG	b1	a1	C1 D	C2 D	C3 D	a2	e1	Ød	Ød1
SG-60-C1/ SG-6-C2/ SG-6-C3	156	156	27 / 37	37	27	58	100	19	20
		196	27 / 37	37	27	98	140	19	20
		246	27 / 37	37	27	148	190	19	20
		311	27 / 37	37	27	213	255	19	20
	196	196	27 / 37	37	27	84	132	24	25
		246	27 / 37	37	27	134	182	24	25
		311	27 / 37	37	27	199	247	24	25
		396	27 / 37	37	27	284	332	24	25
		496	37 / 47	47	27	368	424	30	32
		626	37 / 47	47	27	498	554	30	32
	246	246	37 / 47	47	27	118	174	30	32
		311	37 / 47	47	27	183	239	30	32
		396	37 / 47	47	27	268	324	30	32
		496	37 / 47	47	27	368	424	30	32
		626	47 / 57	47 / 57	27	474	542	38	40
		706	47 / 57	47 / 57	27	554	622	38	40
	311	311	37 / 47	47	27	183	239	30	32
		396	37 / 47	47	27	268	324	30	32
		496	47 / 57	47 / 57	27	344	412	38	40
		626	47 / 57	47 / 57	27	474	542	38	40
		706	47 / 57	47 / 57	27	554	622	38	40
		796	47 / 57	47 / 57	27	644	712	38	40
	396	396	47 / 57	47 / 57	37	244	312	38	40
		496	47 / 57	47 / 57	37	344	412	38	40
626		57 / 67	57 / 67	37	452	530	48	50	
706		57 / 67	57 / 67	37	532	610	48	50	
796		57 / 67	57 / 67	37	622	700	48	50	
496	496	57 / 67	57 / 67	37	322	400	48	50	
	626	57 / 67	57 / 67	37	452	530	48	50	
	706	57 / 67	57 / 67	37	532	610	48	50	
	796	57 / 67	57 / 67	37	622	700	48	50	
626	626	57 / 67	57 / 67	37	452	530	48	50	
	706	57 / 67	57 / 67	37	532	610	48	50	
	796	57 / 67	57 / 67	37	622	700	48	50	

**Combi-Säulengestelle  
mit unten stehenden Säulen**

**Combi-die sets  
with down-mounted columns**

**Combi-blocs à colonnes  
avec colonnes montées en bas**

**Auswahl Gestellplatten**

**Selection die set plates**

**Sélection des plaques de bloc à colonnes**



siehe Seite  
see page 4.62  
voir page

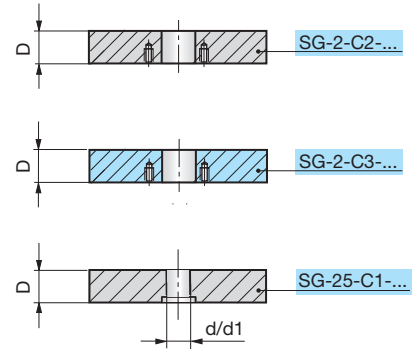
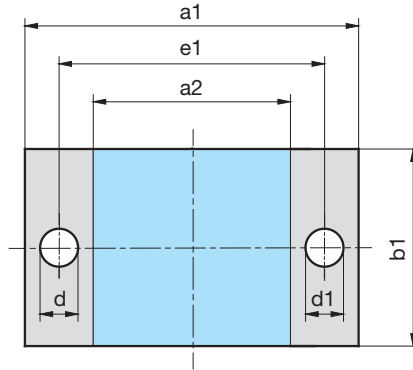

SG-25-C1-  
b1-a1-D-Mat

Mat.: 1.1730/C45W

Mat.: 3.4365 (AL)  
auf Anfrage / on request / sur demande

SG	b1	a1	C1 D	C2 D	C3 D	a2	e1	Ød	Ød1
SG-25-C1/ SG-2-C2/ SG-2-C3	156	156	37	27 / 37	27	48	100	19	20
		196	37	27 / 37	27	88	140	19	20
		246	37	27 / 37	27	138	190	19	20
		311	37	27 / 37	27	203	255	19	20
	196	196	37	27 / 37	27	74	132	24	25
		246	37	27 / 37	27	124	182	24	25
		311	37	27 / 37	27	189	247	24	25
		396	37	27 / 37	27	274	332	24	25
		496	47	37 / 47	27	360	424	30	32
		626	47	37 / 47	27	490	554	30	32
	246	246	47	37 / 47	27	110	174	30	32
		311	47	37 / 47	27	175	239	30	32
		396	47	37 / 47	27	260	324	30	32
		496	47	37 / 47	27	360	424	30	32
		626	47 / 57	47 / 57	27	470	542	38	40
		706	47 / 57	47 / 57	27	550	622	38	40
	311	311	47	37 / 47	27	175	239	30	32
		396	47	37 / 47	27	260	324	30	32
		496	47 / 57	47 / 57	27	340	412	38	40
		626	47 / 57	47 / 57	27	470	542	38	40
		706	47 / 57	47 / 57	27	550	622	38	40
		796	47 / 57	47 / 57	27	640	712	38	40
	396	396	47 / 57	47 / 57	37	240	312	38	40
		496	47 / 57	47 / 57	37	340	412	38	40
626		57 / 67	57 / 67	37	448	530	48	50	
706		57 / 67	57 / 67	37	528	610	48	50	
796		57 / 67	57 / 67	37	618	700	48	50	
496	496	57 / 67	57 / 67	37	318	400	48	50	
	626	57 / 67	57 / 67	37	448	530	48	50	
	706	57 / 67	57 / 67	37	528	610	48	50	
	796	57 / 67	57 / 67	37	618	700	48	50	
626	626	57 / 67	57 / 67	37	448	530	48	50	
	706	57 / 67	57 / 67	37	528	610	48	50	
	796	57 / 67	57 / 67	37	618	700	48	50	

**Combi-Säulengestelle  
mit unten stehenden Säulen**

**Combi-die sets  
with down-mounted columns**

**Combi-blocs à colonnes  
avec colonnes montées en bas**

**Auswahl Gestellplatten**

**Selection die set plates**

**Sélection des plaques de bloc à colonnes**

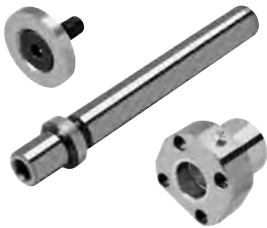

siehe Seite  
see page 4.64  
voir page

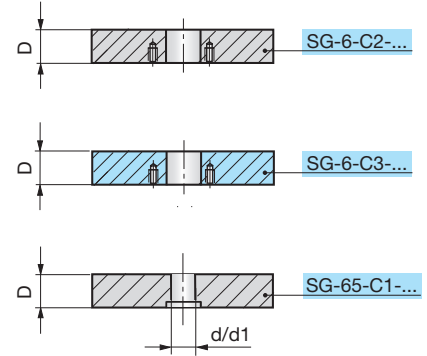
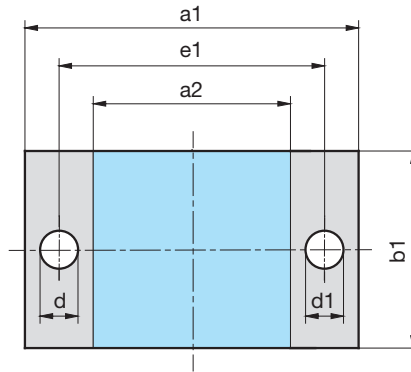

SG-65-C1-  
b1-a1-D-Mat

Mat.: 1.1730/C45W

Mat.: 3.4365 (AL)  
auf Anfrage / on request / sur demande

SG	b1	a1	C1 D	C2 D	C3 D	a2	e1	Ød	Ød1
SG-65-C1/ SG-6-C2/ SG-6-C3	156	156	37	37	27	58	100	19	20
		196	37	37	27	98	140	19	20
		246	37	37	27	148	190	19	20
		311	37	37	27	213	255	19	20
	196	196	37	37	27	84	132	24	25
		246	37	37	27	134	182	24	25
		311	37	37	27	199	247	24	25
		396	37	37	27	284	332	24	25
		496	47	47	27	368	424	30	32
		626	47	47	27	498	554	30	32
	246	246	47	47	27	118	174	30	32
		311	47	47	27	183	239	30	32
		396	47	47	27	268	324	30	32
		496	47	47	27	368	424	30	32
		626	47 / 57	47 / 57	27	474	542	38	40
		706	47 / 57	47 / 57	27	554	622	38	40
	311	311	47	47	27	183	239	30	32
		396	47	47	27	268	324	30	32
		496	47 / 57	47 / 57	27	344	412	38	40
		626	47 / 57	47 / 57	27	474	542	38	40
		706	47 / 57	47 / 57	27	554	622	38	40
		796	47 / 57	47 / 57	27	644	712	38	40
	396	396	47 / 57	47 / 57	37	244	312	38	40
		496	47 / 57	47 / 57	37	344	412	38	40
626		57 / 67	57 / 67	37	452	530	48	50	
706		57 / 67	57 / 67	37	532	610	48	50	
796		57 / 67	57 / 67	37	622	700	48	50	
496	496	57 / 67	57 / 67	37	322	400	48	50	
	626	57 / 67	57 / 67	37	452	530	48	50	
	706	57 / 67	57 / 67	37	532	610	48	50	
	796	57 / 67	57 / 67	37	622	700	48	50	
626	626	57 / 67	57 / 67	37	452	530	48	50	
	706	57 / 67	57 / 67	37	532	610	48	50	
	796	57 / 67	57 / 67	37	622	700	48	50	

**Combi-Säulengestelle  
mit unten stehenden Säulen**
**Combi-die sets  
with down-mounted columns**
**Combi-blocs à colonnes  
avec colonnes montées en bas**
**Auswahl Gestellplatten**
**Selection die set plates**
**Sélection des plaques de bloc à colonnes**

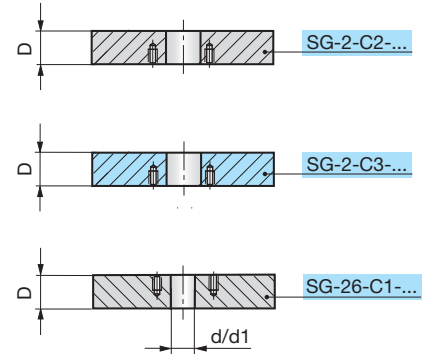
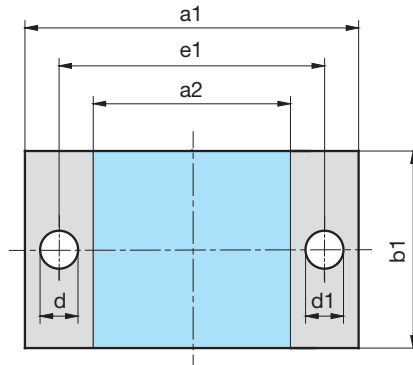
 siehe Seite  
 see page 4.66  
 voir page

 SG-26-C1-  
 b1-a1-D-Mat

Mat.: 1.1730/C45W

 Mat.: 3.4365 (AL)  
 auf Anfrage / on request / sur demande

SG	b1	a1	C1 D	C2 D	C3 D	a2	e1	Ød	Ød1
SG-26-C1/ SG-2-C2/ SG-2-C3	156	156	27 / 37	27 / 37	27	48	100	19	20
		196	27 / 37	27 / 37	27	88	140	19	20
		246	27 / 37	27 / 37	27	138	190	19	20
		311	27 / 37	27 / 37	27	203	255	19	20
	196	196	27 / 37	27 / 37	27	74	132	24	25
		246	27 / 37	27 / 37	27	124	182	24	25
		311	27 / 37	27 / 37	27	189	247	24	25
		396	27 / 37	27 / 37	27	274	332	24	25
		496	37 / 47	37 / 47	27	360	424	30	32
		626	37 / 47	37 / 47	27	490	554	30	32
	246	246	37 / 47	37 / 47	27	110	174	30	32
		311	37 / 47	37 / 47	27	175	239	30	32
		396	37 / 47	37 / 47	27	260	324	30	32
		496	37 / 47	37 / 47	27	360	424	30	32
		626	47 / 57	47 / 57	27	470	542	38	40
		706	47 / 57	47 / 57	27	550	622	38	40
	311	311	37 / 47	37 / 47	27	175	239	30	32
		396	37 / 47	37 / 47	27	260	324	30	32
		496	47 / 57	47 / 57	27	340	412	38	40
		626	47 / 57	47 / 57	27	470	542	38	40
		706	47 / 57	47 / 57	27	550	622	38	40
		796	47 / 57	47 / 57	27	640	712	38	40
	396	396	47 / 57	47 / 57	37	240	312	38	40
		496	47 / 57	47 / 57	37	340	412	38	40
626		57 / 67	57 / 67	37	448	530	48	50	
706		57 / 67	57 / 67	37	528	610	48	50	
796		57 / 67	57 / 67	37	618	700	48	50	
496	496	57 / 67	57 / 67	37	318	400	48	50	
	626	57 / 67	57 / 67	37	448	530	48	50	
	706	57 / 67	57 / 67	37	528	610	48	50	
	796	57 / 67	57 / 67	37	618	700	48	50	
626	626	57 / 67	57 / 67	37	448	530	48	50	
	706	57 / 67	57 / 67	37	528	610	48	50	
	796	57 / 67	57 / 67	37	618	700	48	50	

**Combi-Säulengestelle  
mit unten stehenden Säulen**

**Combi-die sets  
with down-mounted columns**

**Combi-blocs à colonnes  
avec colonnes montées en bas**

**Auswahl Gestellplatten**

**Selection die set plates**

**Sélection des plaques de bloc à colonnes**

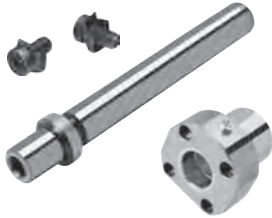

siehe Seite  
see page 4.68  
voir page

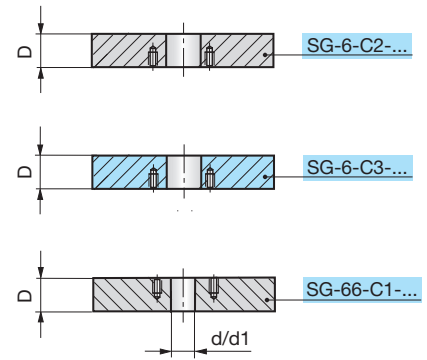
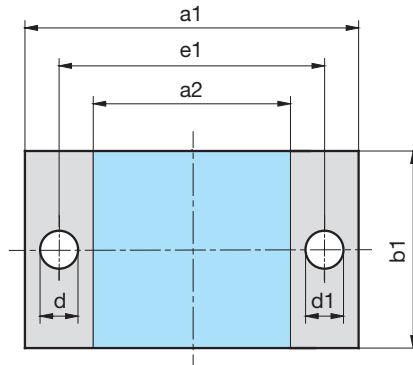

SG-66-C1-  
b1-a1-D-Mat

Mat.: 1.1730/C45W

Mat.: 3.4365 (AL)  
auf Anfrage / on request / sur demande

SG	b1	a1	C1 D	C2 D	C3 D	a2	e1	Ød	Ød1
SG-66-C1/ SG-6-C2/ SG-6-C3	156	156	27 / 37	37	27	58	100	19	20
		196	27 / 37	37	27	98	140	19	20
		246	27 / 37	37	27	148	190	19	20
		311	27 / 37	37	27	213	255	19	20
	196	196	27 / 37	37	27	84	132	24	25
		246	27 / 37	37	27	134	182	24	25
		311	27 / 37	37	27	199	247	24	25
		396	27 / 37	37	27	284	332	24	25
		496	37 / 47	47	27	368	424	30	32
		626	37 / 47	47	27	498	554	30	32
	246	246	37 / 47	47	27	118	174	30	32
		311	37 / 47	47	27	183	239	30	32
		396	37 / 47	47	27	268	324	30	32
		496	37 / 47	47	27	368	424	30	32
		626	47 / 57	47 / 57	27	474	542	38	40
		706	47 / 57	47 / 57	27	554	622	38	40
	311	311	37 / 47	47	27	183	239	30	32
		396	37 / 47	47	27	268	324	30	32
		496	47 / 57	47 / 57	27	344	412	38	40
		626	47 / 57	47 / 57	27	474	542	38	40
706		47 / 57	47 / 57	27	554	622	38	40	
796		47 / 57	47 / 57	27	644	712	38	40	
396	396	47 / 57	47 / 57	37	244	312	38	40	
	496	47 / 57	47 / 57	37	344	412	38	40	
	626	57 / 67	57 / 67	37	452	530	48	50	
	706	57 / 67	57 / 67	37	532	610	48	50	
	796	57 / 67	57 / 67	37	622	700	48	50	
496	496	57 / 67	57 / 67	37	322	400	48	50	
	626	57 / 67	57 / 67	37	452	530	48	50	
	706	57 / 67	57 / 67	37	532	610	48	50	
	796	57 / 67	57 / 67	37	622	700	48	50	
626	626	57 / 67	57 / 67	37	452	530	48	50	
	706	57 / 67	57 / 67	37	532	610	48	50	
	796	57 / 67	57 / 67	37	622	700	48	50	

**Combi-Säulengestelle  
mit unten stehenden Säulen**

**Combi-die sets  
with down-mounted columns**

**Combi-blocs à colonnes  
avec colonnes montées en bas**

**Auswahl Gestellplatten**

**Selection die set plates**

**Sélection des plaques de bloc à colonnes**



siehe Seite  
see page 4.58  
voir page

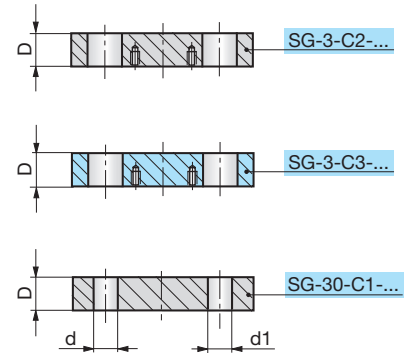
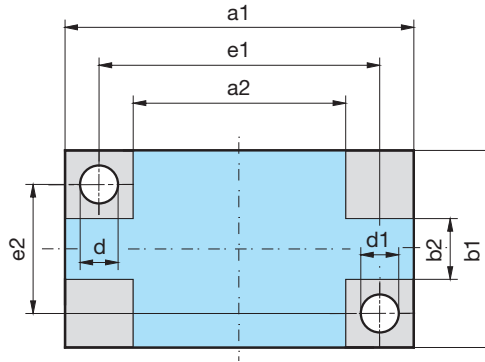

SG-30-C1-  
b1-a1-D-Mat

Mat.: 1.1730/C45W

Mat.: 3.4365 (AL)  
auf Anfrage / on request / sur demande

SG	b1	a1	C1 D	C2 D	C3 D	a2	b2	e1	e2	Ød	Ød1
SG-30-C1/ SG-3-C2/ SG-3-C3	156	156	27 / 37	27 / 37	27	48	48	100	100	19	20
		196	27 / 37	27 / 37	27	88	48	140	100	19	20
		246	27 / 37	27 / 37	27	138	48	190	100	19	20
		311	27 / 37	27 / 37	27	203	48	255	100	19	20
	196	196	27 / 37	27 / 37	27	74	74	132	132	24	25
		246	27 / 37	27 / 37	27	124	74	182	132	24	25
		311	27 / 37	27 / 37	27	189	74	247	132	24	25
		396	27 / 37	27 / 37	27	274	74	332	132	24	25
		496	37 / 47	37 / 47	27	360	60	424	124	30	32
		626	37 / 47	37 / 47	27	490	60	554	124	30	32
	246	246	37 / 47	37 / 47	27	110	110	174	174	30	32
		311	37 / 47	37 / 47	27	175	110	239	174	30	32
		396	37 / 47	37 / 47	27	260	110	324	174	30	32
		496	37 / 47	37 / 47	27	360	110	424	174	30	32
		626	47 / 57	47 / 57	27	470	90	542	162	38	40
		706	47 / 57	47 / 57	27	550	90	622	162	38	40
	311	311	37 / 47	37 / 47	27	175	175	239	239	30	32
		396	37 / 47	37 / 47	27	260	175	324	239	30	32
		496	47 / 57	47 / 57	27	340	155	412	227	38	40
		626	47 / 57	47 / 57	27	470	155	542	227	38	40
706		47 / 57	47 / 57	27	550	155	622	227	38	40	
796		47 / 57	47 / 57	27	640	155	712	227	38	40	
396	396	47 / 57	47 / 57	37	240	240	312	312	38	40	
	496	47 / 57	47 / 57	37	340	240	412	312	38	40	
	626	57 / 67	57 / 67	37	448	218	530	300	48	50	
	706	57 / 67	57 / 67	37	528	218	610	300	48	50	
	796	57 / 67	57 / 67	37	618	218	700	300	48	50	
496	496	57 / 67	57 / 67	37	318	318	400	400	48	50	
	626	57 / 67	57 / 67	37	448	318	530	400	48	50	
	706	57 / 67	57 / 67	37	528	318	610	400	48	50	
	796	57 / 67	57 / 67	37	618	318	700	400	48	50	
626	626	57 / 67	57 / 67	37	448	448	530	530	48	50	
	706	57 / 67	57 / 67	37	528	448	610	530	48	50	
	796	57 / 67	57 / 67	37	618	448	700	530	48	50	



**Combi-Säulengestelle  
mit unten stehenden Säulen**

**Combi-die sets  
with down-mounted columns**

**Combi-blocs à colonnes  
avec colonnes montées en bas**

**Auswahl Gestellplatten**

**Selection die set plates**

**Sélection des plaques de bloc à colonnes**



siehe Seite  
see page **4.60**  
voir page

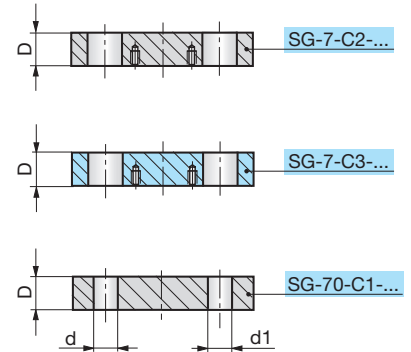
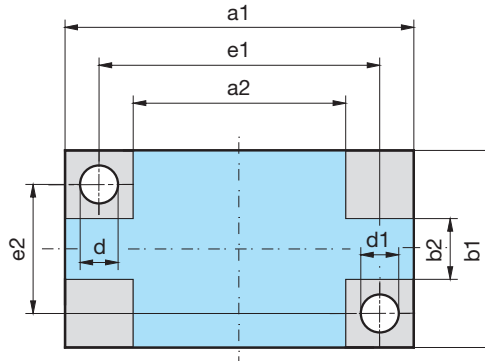

SG-70-C1-  
b1-a1-D-Mat

Mat.: 1.1730/C45W

Mat.: 3.4365 (AL)  
auf Anfrage / on request / sur demande

SG	b1	a1	C1 D	C2 D	C3 D	a2	b2	e1	e2	Ød	Ød1
SG-70-C1/ SG-7-C2/ SG-7-C3	156	156	27 / 37	37	27	58	58	100	100	19	20
		196	27 / 37	37	27	98	58	140	100	19	20
		246	27 / 37	37	27	148	58	190	100	19	20
		311	27 / 37	37	27	213	58	255	100	19	20
	196	196	27 / 37	37	27	84	84	132	132	24	25
		246	27 / 37	37	27	134	84	182	132	24	25
		311	27 / 37	37	27	199	84	247	132	24	25
		396	27 / 37	37	27	284	84	332	132	24	25
		496	37 / 47	47	27	368	68	424	124	30	32
		626	37 / 47	47	27	498	68	554	124	30	32
	246	246	37 / 47	47	27	118	118	174	174	30	32
		311	37 / 47	47	27	183	118	239	174	30	32
		396	37 / 47	47	27	268	118	324	174	30	32
		496	37 / 47	47	27	368	118	424	174	30	32
		626	47 / 57	47 / 57	27	474	94	542	162	38	40
		706	47 / 57	47 / 57	27	554	94	622	162	38	40
	311	311	37 / 47	47	27	183	183	239	239	30	32
		396	37 / 47	47	27	268	183	324	239	30	32
		496	47 / 57	47 / 57	27	344	159	412	227	38	40
		626	47 / 57	47 / 57	27	474	159	542	227	38	40
		706	47 / 57	47 / 57	27	554	159	622	227	38	40
		796	47 / 57	47 / 57	27	644	159	712	227	38	40
	396	396	47 / 57	47 / 57	37	244	244	312	312	38	40
		496	47 / 57	47 / 57	37	344	244	412	312	38	40
626		57 / 67	57 / 67	37	452	222	530	300	48	50	
706		57 / 67	57 / 67	37	532	222	610	300	48	50	
796		57 / 67	57 / 67	37	622	222	700	300	48	50	
496	496	57 / 67	57 / 67	37	322	224	400	400	48	50	
	626	57 / 67	57 / 67	37	452	224	530	400	48	50	
	706	57 / 67	57 / 67	37	532	224	610	400	48	50	
	796	57 / 67	57 / 67	37	622	322	700	400	48	50	
626	626	57 / 67	57 / 67	37	452	452	530	530	48	50	
	706	57 / 67	57 / 67	37	532	452	610	530	48	50	
	796	57 / 67	57 / 67	37	622	452	700	530	48	50	

**Combi-Säulengestelle mit unten stehenden Säulen**

**Combi-die sets with down-mounted columns**

**Combi-blocs à colonnes avec colonnes montées en bas**

**Auswahl Gestellplatten**

**Selection die set plates**

**Sélection des plaques de bloc à colonnes**



siehe Seite  
see page 4.62  
voir page

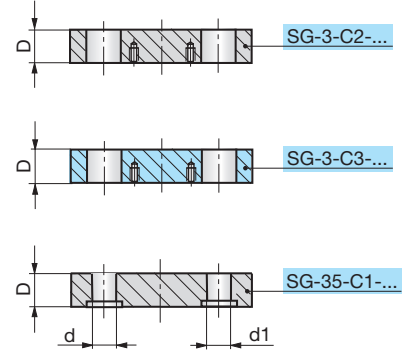
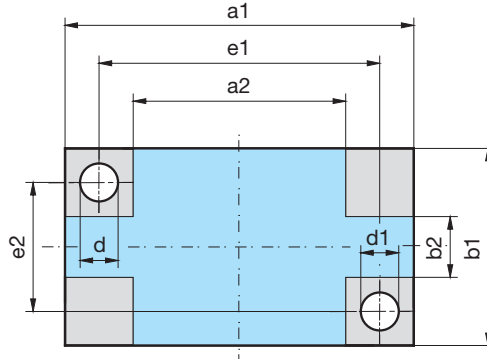

4



SG-35-C1-  
b1-a1-D-Mat

Mat.: 1.1730/C45W

Mat.: 3.4365 (AL)  
auf Anfrage / on request / sur demande

SG	b1	a1	C1 D	C2 D	C3 D	a2	b2	e1	e2	Ød	Ød1
SG-35-C1/ SG-3-C2/ SG-3-C3	156	156	37	27 / 37	27	48	48	100	100	19	20
		196	37	27 / 37	27	88	48	140	100	19	20
		246	37	27 / 37	27	138	48	190	100	19	20
		311	37	27 / 37	27	203	48	255	100	19	20
	196	196	37	27 / 37	27	74	74	132	132	24	25
		246	37	27 / 37	27	124	74	182	132	24	25
		311	37	27 / 37	27	189	74	247	132	24	25
		396	37	27 / 37	27	274	74	332	132	24	25
		496	47	37 / 47	27	360	60	424	124	30	32
		626	47	37 / 47	27	490	60	554	124	30	32
	246	246	47	37 / 47	27	110	110	174	174	30	32
		311	47	37 / 47	27	175	110	239	174	30	32
		396	47	37 / 47	27	260	110	324	174	30	32
		496	47	37 / 47	27	360	110	424	174	30	32
		626	47 / 57	47 / 57	27	470	90	542	162	38	40
		706	47 / 57	47 / 57	27	550	90	622	162	38	40
	311	311	47	37 / 47	27	175	175	239	239	30	32
		396	47	37 / 47	27	260	175	324	239	30	32
		496	47 / 57	47 / 57	27	340	155	412	227	38	40
		626	47 / 57	47 / 57	27	470	155	542	227	38	40
		706	47 / 57	47 / 57	27	550	155	622	227	38	40
		796	47 / 57	47 / 57	27	640	155	712	227	38	40
	396	396	47 / 57	47 / 57	37	240	240	312	312	38	40
		496	47 / 57	47 / 57	37	340	240	412	312	38	40
626		57 / 67	57 / 67	37	448	218	530	300	48	50	
706		57 / 67	57 / 67	37	528	218	610	300	48	50	
796		57 / 67	57 / 67	37	618	218	700	300	48	50	
496	496	57 / 67	57 / 67	37	318	318	400	400	48	50	
	626	57 / 67	57 / 67	37	448	318	530	400	48	50	
	706	57 / 67	57 / 67	37	528	318	610	400	48	50	
	796	57 / 67	57 / 67	37	618	318	700	400	48	50	
626	626	57 / 67	57 / 67	37	448	448	530	530	48	50	
	706	57 / 67	57 / 67	37	528	448	610	530	48	50	
	796	57 / 67	57 / 67	37	618	448	700	530	48	50	

**Combi-Säulengestelle  
mit unten stehenden Säulen**

**Combi-die sets  
with down-mounted columns**

**Combi-blocs à colonnes  
avec colonnes montées en bas**

**Auswahl Gestellplatten**

**Selection die set plates**

**Sélection des plaques de bloc à colonnes**

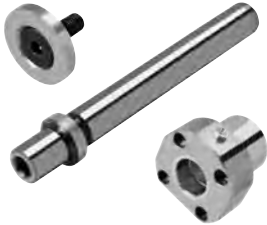

siehe Seite  
see page 4.64  
voir page

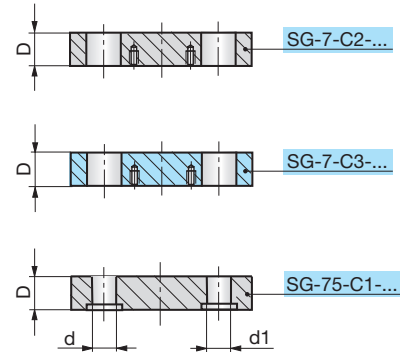
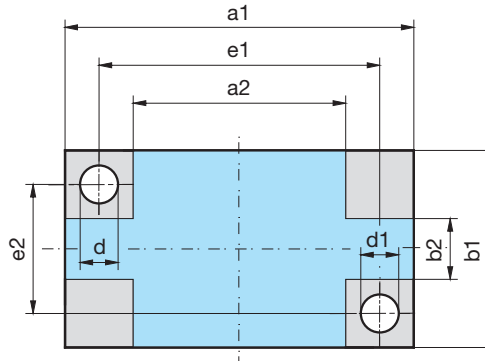

SG-75-C1-  
b1-a1-D-Mat

Mat.: 1.1730/C45W

Mat.: 3.4365 (AL)  
auf Anfrage / on request / sur demande

SG	b1	a1	C1 D	C2 D	C3 D	a2	b2	e1	e2	Ød	Ød1
SG-75-C1/ SG-7-C2/ SG-7-C3	156	156	37	37	27	58	58	100	100	19	20
		196	37	37	27	98	58	140	100	19	20
		246	37	37	27	148	58	190	100	19	20
		311	37	37	27	213	58	255	100	19	20
	196	196	37	37	27	84	84	132	132	24	25
		246	37	37	27	134	84	182	132	24	25
		311	37	37	27	199	84	247	132	24	25
		396	37	37	27	284	84	332	132	24	25
		496	47	47	27	368	68	424	124	30	32
		626	47	47	27	498	68	554	124	30	32
	246	246	47	47	27	118	118	174	174	30	32
		311	47	47	27	183	118	239	174	30	32
		396	47	47	27	268	118	324	174	30	32
		496	47	47	27	368	118	424	174	30	32
		626	47 / 57	47 / 57	27	474	94	542	162	38	40
		706	47 / 57	47 / 57	27	554	94	622	162	38	40
	311	311	47	47	27	183	183	239	239	30	32
		396	47	47	27	268	183	324	239	30	32
		496	47 / 57	47 / 57	27	344	159	412	227	38	40
		626	47 / 57	47 / 57	27	474	159	542	227	38	40
706		47 / 57	47 / 57	27	554	159	622	227	38	40	
796		47 / 57	47 / 57	27	644	159	712	227	38	40	
396	396	47 / 57	47 / 57	37	244	244	312	312	38	40	
	496	47 / 57	47 / 57	37	344	244	412	312	38	40	
	626	57 / 67	57 / 67	37	452	222	530	300	48	50	
	706	57 / 67	57 / 67	37	532	222	610	300	48	50	
	796	57 / 67	57 / 67	37	622	222	700	300	48	50	
496	496	57 / 67	57 / 67	37	322	224	400	400	48	50	
	626	57 / 67	57 / 67	37	452	224	530	400	48	50	
	706	57 / 67	57 / 67	37	532	224	610	400	48	50	
	796	57 / 67	57 / 67	37	622	322	700	400	48	50	
626	626	57 / 67	57 / 67	37	452	452	530	530	48	50	
	706	57 / 67	57 / 67	37	532	452	610	530	48	50	
	796	57 / 67	57 / 67	37	622	452	700	530	48	50	



**Combi-Säulengestelle  
mit unten stehenden Säulen**

**Combi-die sets  
with down-mounted columns**

**Combi-blocs à colonnes  
avec colonnes montées en bas**

**Auswahl Gestellplatten**

**Selection die set plates**

**Sélection des plaques de bloc à colonnes**

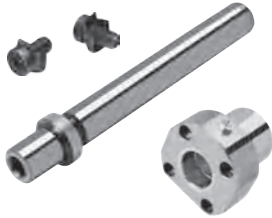

siehe Seite  
see page **4.68**  
voir page

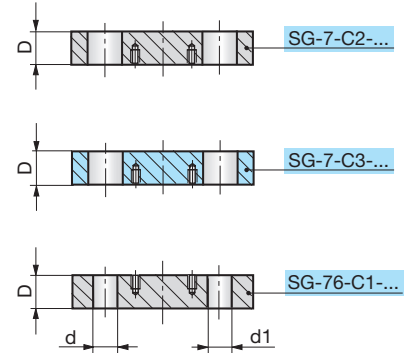
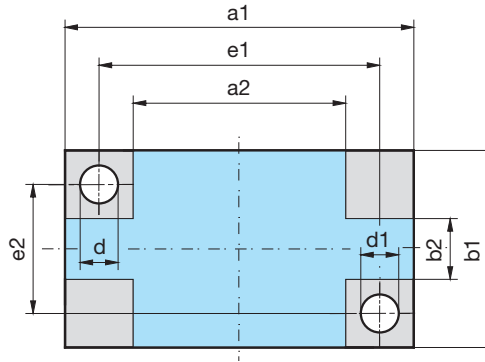

SG-76-C1-  
b1-a1-D-Mat

Mat.: 1.1730/C45W

Mat.: 3.4365 (AL)  
auf Anfrage / on request / sur demande

SG	b1	a1	C1 D	C2 D	C3 D	a2	b2	e1	e2	Ød	Ød1
SG-76-C1/ SG-7-C2/ SG-7-C3	156	156	27 / 37	37	27	58	58	100	100	19	20
		196	27 / 37	37	27	98	58	140	100	19	20
		246	27 / 37	37	27	148	58	190	100	19	20
		311	27 / 37	37	27	213	58	255	100	19	20
	196	196	27 / 37	37	27	84	84	132	132	24	25
		246	27 / 37	37	27	134	84	182	132	24	25
		311	27 / 37	37	27	199	84	247	132	24	25
		396	27 / 37	37	27	284	84	332	132	24	25
		496	37 / 47	47	27	368	68	424	124	30	32
		626	37 / 47	47	27	498	68	554	124	30	32
	246	246	37 / 47	47	27	118	118	174	174	30	32
		311	37 / 47	47	27	183	118	239	174	30	32
396		37 / 47	47	27	268	118	324	174	30	32	
496		37 / 47	47	27	368	118	424	174	30	32	
626		47 / 57	47 / 57	27	474	94	542	162	38	40	
706		47 / 57	47 / 57	27	554	94	622	162	38	40	
311	311	37 / 47	47	27	183	183	239	239	30	32	
	396	37 / 47	47	27	268	183	324	239	30	32	
	496	47 / 57	47 / 57	27	344	159	412	227	38	40	
	626	47 / 57	47 / 57	27	474	159	542	227	38	40	
	706	47 / 57	47 / 57	27	554	159	622	227	38	40	
	796	47 / 57	47 / 57	27	644	159	712	227	38	40	
396	396	47 / 57	47 / 57	37	244	244	312	312	38	40	
	496	47 / 57	47 / 57	37	344	244	412	312	38	40	
	626	57 / 67	57 / 67	37	452	222	530	300	48	50	
	706	57 / 67	57 / 67	37	532	222	610	300	48	50	
	796	57 / 67	57 / 67	37	622	222	700	300	48	50	
496	496	57 / 67	57 / 67	37	322	224	400	400	48	50	
	626	57 / 67	57 / 67	37	452	224	530	400	48	50	
	706	57 / 67	57 / 67	37	532	224	610	400	48	50	
	796	57 / 67	57 / 67	37	622	322	700	400	48	50	
626	626	57 / 67	57 / 67	37	452	452	530	530	48	50	
	706	57 / 67	57 / 67	37	532	452	610	530	48	50	
	796	57 / 67	57 / 67	37	622	452	700	530	48	50	

**Combi-Säulengestelle  
mit unten stehenden Säulen**

**Combi-die sets  
with down-mounted columns**

**Combi-blocs à colonnes  
avec colonnes montées en bas**

**Auswahl Gestellplatten**

**Selection die set plates**

**Sélection des plaques de bloc à colonnes**



siehe Seite  
see page 4.58  
voir page

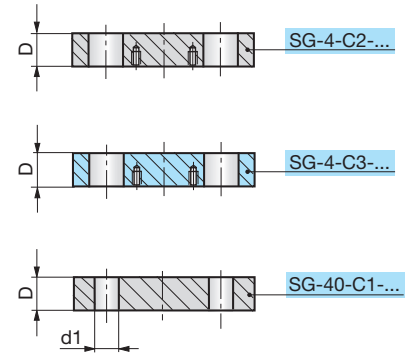
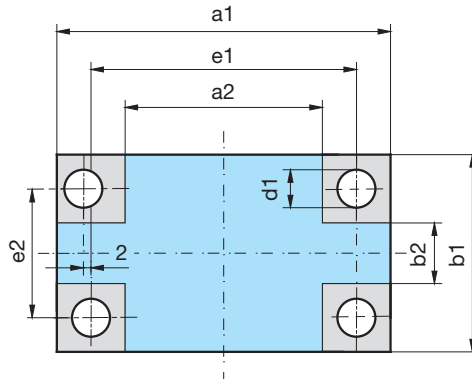

SG-40-C1-  
b1-a1-D-Mat

Mat.: 1.1730/C45W

Mat.: 3.4365 (AL)  
auf Anfrage / on request / sur demande

SG	b1	a1	C1 D	C2 D	C3 D	a2	b2	e1	e2	Ød1
SG-40-C1/ SG-4-C2/ SG-4-C3	156	156	27 / 37	27 / 37	27	48	48	100	100	20
		196	27 / 37	27 / 37	27	88	48	140	100	20
		246	27 / 37	27 / 37	27	138	48	190	100	20
		311	27 / 37	27 / 37	27	203	48	255	100	20
	196	196	27 / 37	27 / 37	27	74	74	132	132	25
		246	27 / 37	27 / 37	27	124	74	182	132	25
		311	27 / 37	27 / 37	27	189	74	247	132	25
		396	27 / 37	27 / 37	27	274	74	332	132	25
		496	37 / 47	37 / 47	27	360	60	424	124	32
		626	37 / 47	37 / 47	27	490	60	554	124	32
	246	246	37 / 47	37 / 47	27	110	110	174	174	32
		311	37 / 47	37 / 47	27	175	110	239	174	32
		396	37 / 47	37 / 47	27	260	110	324	174	32
		496	37 / 47	37 / 47	27	360	110	424	174	32
		626	47 / 57	47 / 57	27	470	90	542	162	40
		706	47 / 57	47 / 57	27	550	90	622	162	40
	311	311	37 / 47	37 / 47	27	175	175	239	239	32
		396	37 / 47	37 / 47	27	260	175	324	239	32
		496	47 / 57	47 / 57	27	340	155	412	227	40
		626	47 / 57	47 / 57	27	470	155	542	227	40
706		47 / 57	47 / 57	27	550	155	622	227	40	
796		47 / 57	47 / 57	27	640	155	712	227	40	
396	396	47 / 57	47 / 57	37	240	240	312	312	40	
	496	47 / 57	47 / 57	37	340	240	412	312	40	
	626	57 / 67	57 / 67	37	448	218	530	300	50	
	706	57 / 67	57 / 67	37	528	218	610	300	50	
	796	57 / 67	57 / 67	37	618	218	700	300	50	
496	496	57 / 67	57 / 67	37	318	318	400	400	50	
	626	57 / 67	57 / 67	37	448	318	530	400	50	
	706	57 / 67	57 / 67	37	528	318	610	400	50	
	796	57 / 67	57 / 67	37	618	318	700	400	50	
626	626	57 / 67	57 / 67	37	448	448	530	530	50	
	706	57 / 67	57 / 67	37	528	448	610	530	50	
	796	57 / 67	57 / 67	37	618	448	700	530	50	

**Combi-Säulengestelle  
mit unten stehenden Säulen**

**Combi-die sets  
with down-mounted columns**

**Combi-blocs à colonnes  
avec colonnes montées en bas**

**Auswahl Gestellplatten**

**Selection die set plates**

**Sélection des plaques de bloc à colonnes**



siehe Seite  
see page **4.60**  
voir page

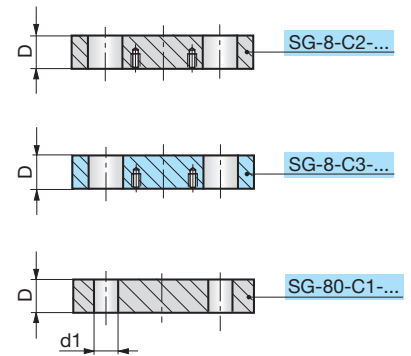
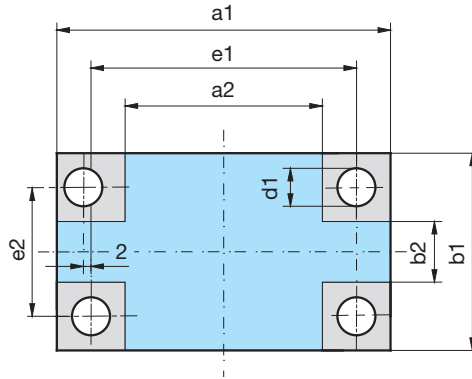

SG-80-C1-  
b1-a1-D-Mat

Mat.: 1.1730/C45W

Mat.: 3.4365 (AL)  
auf Anfrage / on request / sur demande

SG	b1	a1	C1 D	C2 D	C3 D	a2	b2	e1	e2	Ød1
SG-80-C1/ SG-8-C2/ SG-8-C3	156	156	27 / 37	37	27	58	58	100	100	20
		196	27 / 37	37	27	98	58	140	100	20
		246	27 / 37	37	27	148	58	190	100	20
		311	27 / 37	37	27	213	58	255	100	20
	196	196	27 / 37	37	27	84	84	132	132	25
		246	27 / 37	37	27	134	84	182	132	25
		311	27 / 37	37	27	199	84	247	132	25
		396	27 / 37	37	27	284	84	332	132	25
		496	37 / 47	47	27	368	68	424	124	32
		626	37 / 47	47	27	498	68	554	124	32
	246	246	37 / 47	47	27	118	118	174	174	32
		311	37 / 47	47	27	183	118	239	174	32
		396	37 / 47	47	27	268	118	324	174	32
		496	37 / 47	47	27	368	118	424	174	32
		626	47 / 57	47 / 57	27	474	94	542	162	40
		706	47 / 57	47 / 57	27	554	94	622	162	40
	311	311	37 / 47	47	27	183	183	239	239	32
		396	37 / 47	47	27	268	183	324	239	32
		496	47 / 57	47 / 57	27	344	159	412	227	40
		626	47 / 57	47 / 57	27	474	159	542	227	40
		706	47 / 57	47 / 57	27	554	159	622	227	40
		796	47 / 57	47 / 57	27	644	159	712	227	40
	396	396	47 / 57	47 / 57	37	244	244	312	312	40
		496	47 / 57	47 / 57	37	344	244	412	312	40
		626	57 / 67	57 / 67	37	452	222	530	300	50
		706	57 / 67	57 / 67	37	532	222	610	300	50
		796	57 / 67	57 / 67	37	622	222	700	300	50
	496	496	57 / 67	57 / 67	37	322	322	400	400	50
626		57 / 67	57 / 67	37	452	322	530	400	50	
706		57 / 67	57 / 67	37	532	322	610	400	50	
796		57 / 67	57 / 67	37	622	322	700	400	50	
626	626	57 / 67	57 / 67	37	452	452	530	530	50	
	706	57 / 67	57 / 67	37	532	452	610	530	50	
	796	57 / 67	57 / 67	37	622	452	700	530	50	

**Combi-Säulengestelle  
mit unten stehenden Säulen**

**Combi-die sets  
with down-mounted columns**

**Combi-blocs à colonnes  
avec colonnes montées en bas**

**Auswahl Gestellplatten**

**Selection die set plates**

**Sélection des plaques de bloc à colonnes**



siehe Seite  
see page 4.62  
voir page

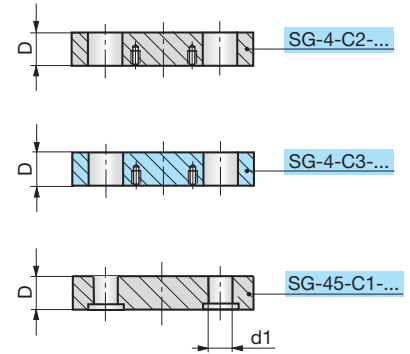
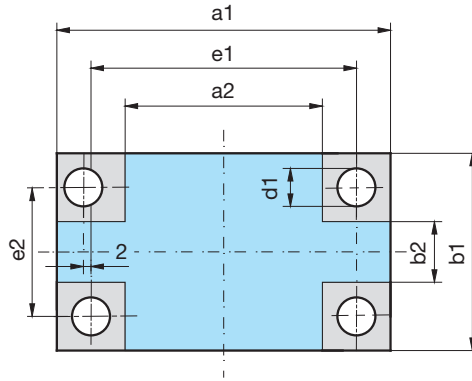

SG-45-C1-  
b1-a1-D-Mat

Mat.: 1.1730/C45W

Mat.: 3.4365 (AL)  
auf Anfrage / on request / sur demande

SG	b1	a1	C1 D	C2 D	C3 D	a2	b2	e1	e2	Ød1
SG-45-C1/ SG-4-C2/ SG-4-C3	156	156	37	27 / 37	27	48	48	100	100	20
		196	37	27 / 37	27	88	48	140	100	20
		246	37	27 / 37	27	138	48	190	100	20
		311	37	27 / 37	27	203	48	255	100	20
	196	196	37	27 / 37	27	74	74	132	132	25
		246	37	27 / 37	27	124	74	182	132	25
		311	37	27 / 37	27	189	74	247	132	25
		396	37	27 / 37	27	274	74	332	132	25
		496	47	37 / 47	27	360	60	424	124	32
		626	47	37 / 47	27	490	60	554	124	32
	246	246	47	37 / 47	27	110	110	174	174	32
		311	47	37 / 47	27	175	110	239	174	32
		396	47	37 / 47	27	260	110	324	174	32
		496	47	37 / 47	27	360	110	424	174	32
		626	47 / 57	47 / 57	27	470	90	542	162	40
		706	47 / 57	47 / 57	27	550	90	622	162	40
	311	311	47	37 / 47	27	175	175	239	239	32
		396	47	37 / 47	27	260	175	324	239	32
		496	47 / 57	47 / 57	27	340	155	412	227	40
		626	47 / 57	47 / 57	27	470	155	542	227	40
706		47 / 57	47 / 57	27	550	155	622	227	40	
796		47 / 57	47 / 57	27	640	155	712	227	40	
396	396	47 / 57	47 / 57	37	240	240	312	312	40	
	496	47 / 57	47 / 57	37	340	240	412	312	40	
	626	57 / 67	57 / 67	37	448	218	530	300	50	
	706	57 / 67	57 / 67	37	528	218	610	300	50	
	796	57 / 67	57 / 67	37	618	218	700	300	50	
496	496	57 / 67	57 / 67	37	318	318	400	400	50	
	626	57 / 67	57 / 67	37	448	318	530	400	50	
	706	57 / 67	57 / 67	37	528	318	610	400	50	
	796	57 / 67	57 / 67	37	618	318	700	400	50	
626	626	57 / 67	57 / 67	37	448	448	530	530	50	
	706	57 / 67	57 / 67	37	528	448	610	530	50	
	796	57 / 67	57 / 67	37	618	448	700	530	50	



**Combi-Säulengestelle  
mit unten stehenden Säulen**

**Combi-die sets  
with down-mounted columns**

**Combi-blocs à colonnes  
avec colonnes montées en bas**

**Auswahl Gestellplatten**

**Selection die set plates**

**Sélection des plaques de bloc à colonnes**

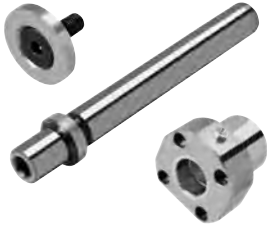

siehe Seite  
see page 4.64  
voir page

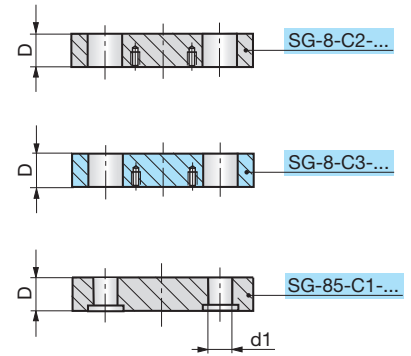
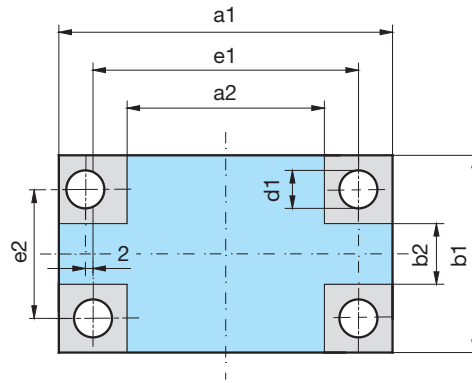

SG-85-C1-  
b1-a1-D-Mat

Mat.: 1.1730/C45W

Mat.: 3.4365 (AL)  
auf Anfrage / on request / sur demande

SG	b1	a1	C1 D	C2 D	C3 D	a2	b2	e1	e2	Ød1
SG-85-C1/ SG-8-C2/ SG-8-C3	156	156	37	37	27	58	58	100	100	20
		196	37	37	27	98	58	140	100	20
		246	37	37	27	148	58	190	100	20
		311	37	37	27	213	58	255	100	20
	196	196	37	37	27	84	84	132	132	25
		246	37	37	27	134	84	182	132	25
		311	37	37	27	199	84	247	132	25
		396	37	37	27	284	84	332	132	25
		496	47	47	27	368	68	424	124	32
		626	47	47	27	498	68	554	124	32
	246	246	47	47	27	118	118	174	174	32
		311	47	47	27	183	118	239	174	32
		396	47	47	27	268	118	324	174	32
		496	47	47	27	368	118	424	174	32
		626	47 / 57	47 / 57	27	474	94	542	162	40
		706	47 / 57	47 / 57	27	554	94	622	162	40
	311	311	47	47	27	183	183	239	239	32
		396	47	47	27	268	183	324	239	32
		496	47 / 57	47 / 57	27	344	159	412	227	40
		626	47 / 57	47 / 57	27	474	159	542	227	40
		706	47 / 57	47 / 57	27	554	159	622	227	40
		796	47 / 57	47 / 57	27	644	159	712	227	40
	396	396	47 / 57	47 / 57	37	244	244	312	312	40
		496	47 / 57	47 / 57	37	344	244	412	312	40
		626	57 / 67	57 / 67	37	452	222	530	300	50
		706	57 / 67	57 / 67	37	532	222	610	300	50
		796	57 / 67	57 / 67	37	622	222	700	300	50
	496	496	57 / 67	57 / 67	37	322	322	400	400	50
626		57 / 67	57 / 67	37	452	322	530	400	50	
706		57 / 67	57 / 67	37	532	322	610	400	50	
796		57 / 67	57 / 67	37	622	322	700	400	50	
626	626	57 / 67	57 / 67	37	452	452	530	530	50	
	706	57 / 67	57 / 67	37	532	452	610	530	50	
	796	57 / 67	57 / 67	37	622	452	700	530	50	

**Combi-Säulengestelle  
mit unten stehenden Säulen**

**Combi-die sets  
with down-mounted columns**

**Combi-blocs à colonnes  
avec colonnes montées en bas**

**Auswahl Gestellplatten**

**Selection die set plates**

**Sélection des plaques de bloc à colonnes**



siehe Seite  
see page 4.66  
voir page

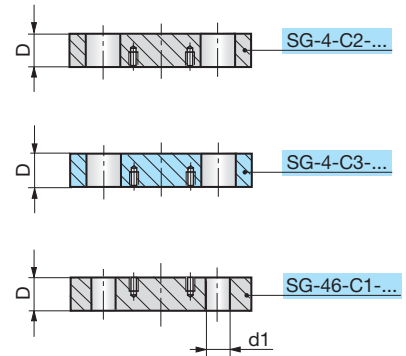
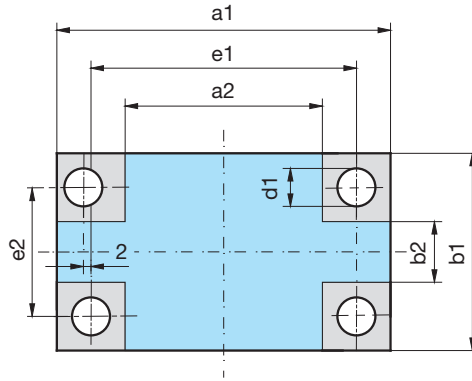

SG-46-C1-  
b1-a1-D-Mat

Mat.: 1.1730/C45W

Mat.: 3.4365 (AL)  
auf Anfrage / on request / sur demande

SG	b1	a1	C1 D	C2 D	C3 D	a2	b2	e1	e2	Ød1
SG-46-C1/ SG-4-C2/ SG-4-C3	156	156	27 / 37	27 / 37	27	48	48	100	100	20
		196	27 / 37	27 / 37	27	88	48	140	100	20
		246	27 / 37	27 / 37	27	138	48	190	100	20
		311	27 / 37	27 / 37	27	203	48	255	100	20
	196	196	27 / 37	27 / 37	27	74	74	132	132	25
		246	27 / 37	27 / 37	27	124	74	182	132	25
		311	27 / 37	27 / 37	27	189	74	247	132	25
		396	27 / 37	27 / 37	27	274	74	332	132	25
		496	37 / 47	37 / 47	27	360	60	424	124	32
		626	37 / 47	37 / 47	27	490	60	554	124	32
	246	246	37 / 47	37 / 47	27	110	110	174	174	32
		311	37 / 47	37 / 47	27	175	110	239	174	32
		396	37 / 47	37 / 47	27	260	110	324	174	32
		496	37 / 47	37 / 47	27	360	110	424	174	32
		626	47 / 57	47 / 57	27	470	90	542	162	40
		706	47 / 57	47 / 57	27	550	90	622	162	40
	311	311	37 / 47	37 / 47	27	175	175	239	239	32
		396	37 / 47	37 / 47	27	260	175	324	239	32
		496	47 / 57	47 / 57	27	340	155	412	227	40
		626	47 / 57	47 / 57	27	470	155	542	227	40
706		47 / 57	47 / 57	27	550	155	622	227	40	
796		47 / 57	47 / 57	27	640	155	712	227	40	
396	396	47 / 57	47 / 57	37	240	240	312	312	40	
	496	47 / 57	47 / 57	37	340	240	412	312	40	
	626	57 / 67	57 / 67	37	448	218	530	300	50	
	706	57 / 67	57 / 67	37	528	218	610	300	50	
	796	57 / 67	57 / 67	37	618	218	700	300	50	
496	496	57 / 67	57 / 67	37	318	318	400	400	50	
	626	57 / 67	57 / 67	37	448	318	530	400	50	
	706	57 / 67	57 / 67	37	528	318	610	400	50	
	796	57 / 67	57 / 67	37	618	318	700	400	50	
626	626	57 / 67	57 / 67	37	448	448	530	530	50	
	706	57 / 67	57 / 67	37	528	448	610	530	50	
	796	57 / 67	57 / 67	37	618	448	700	530	50	

**Combi-Säulengestelle  
mit unten stehenden Säulen**

**Combi-die sets  
with down-mounted columns**

**Combi-blocs à colonnes  
avec colonnes montées en bas**

**Auswahl Gestellplatten**

**Selection die set plates**

**Sélection des plaques de bloc à colonnes**

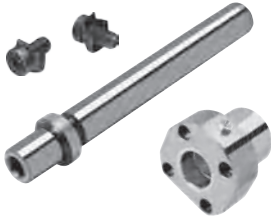

siehe Seite  
see page 4.68  
voir page

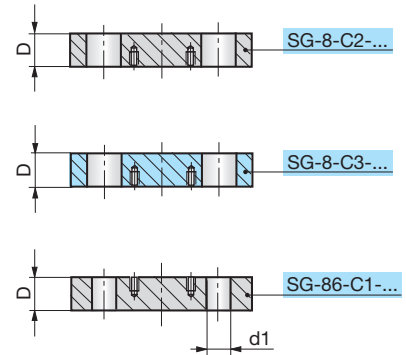
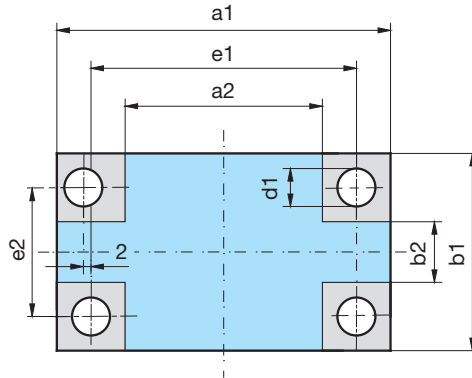

SG-86-C1-  
b1-a1-D-Mat

Mat.: 1.1730/C45W

Mat.: 3.4365 (AL)  
auf Anfrage / on request / sur demande

SG	b1	a1	C1 D	C2 D	C3 D	a2	b2	e1	e2	Ød1
SG-86-C1/ SG-8-C2/ SG-8-C3	156	156	27 / 37	37	27	58	58	100	100	20
		196	27 / 37	37	27	98	58	140	100	20
		246	27 / 37	37	27	148	58	190	100	20
		311	27 / 37	37	27	213	58	255	100	20
	196	196	27 / 37	37	27	84	84	132	132	25
		246	27 / 37	37	27	134	84	182	132	25
		311	27 / 37	37	27	199	84	247	132	25
		396	27 / 37	37	27	284	84	332	132	25
		496	37 / 47	47	27	368	68	424	124	32
		626	37 / 47	47	27	498	68	554	124	32
	246	246	37 / 47	47	27	118	118	174	174	32
		311	37 / 47	47	27	183	118	239	174	32
		396	37 / 47	47	27	268	118	324	174	32
		496	37 / 47	47	27	368	118	424	174	32
		626	47 / 57	47 / 57	27	474	94	542	162	40
		706	47 / 57	47 / 57	27	554	94	622	162	40
	311	311	37 / 47	47	27	183	183	239	239	32
		396	37 / 47	47	27	268	183	324	239	32
		496	47 / 57	47 / 57	27	344	159	412	227	40
		626	47 / 57	47 / 57	27	474	159	542	227	40
		706	47 / 57	47 / 57	27	554	159	622	227	40
		796	47 / 57	47 / 57	27	644	159	712	227	40
	396	396	47 / 57	47 / 57	37	244	244	312	312	40
		496	47 / 57	47 / 57	37	344	244	412	312	40
		626	57 / 67	57 / 67	37	452	222	530	300	50
		706	57 / 67	57 / 67	37	532	222	610	300	50
		796	57 / 67	57 / 67	37	622	222	700	300	50
	496	496	57 / 67	57 / 67	37	322	322	400	400	50
626		57 / 67	57 / 67	37	452	322	530	400	50	
706		57 / 67	57 / 67	37	532	322	610	400	50	
796		57 / 67	57 / 67	37	622	322	700	400	50	
626	626	57 / 67	57 / 67	37	452	452	530	530	50	
	706	57 / 67	57 / 67	37	532	452	610	530	50	
	796	57 / 67	57 / 67	37	622	452	700	530	50	

**Combi-Säulengestelle  
mit unten stehenden Säulen**

**Combi-die sets  
with down-mounted columns**

**Combi-blocs à colonnes  
avec colonnes montées en bas**

**Auswahl Gestellplatten**

**Selection die set plates**

**Sélection des plaques de bloc à colonnes**



siehe Seite  
see page 4.58  
voir page

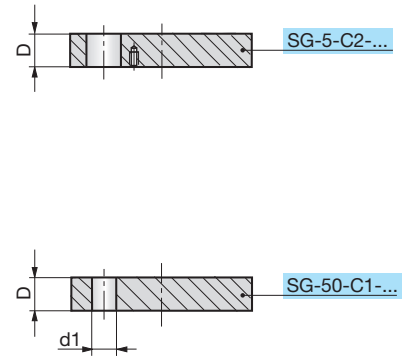
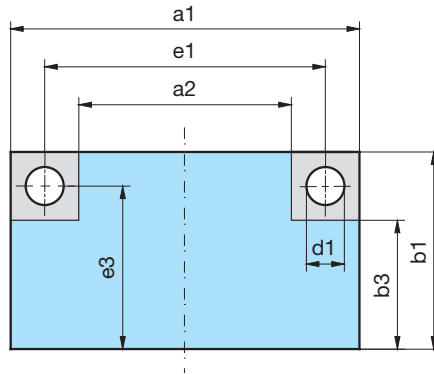

SG-50-C1-  
b1-a1-D-Mat

Mat.: 1.1730/C45W

Mat.: 3.4365 (AL)  
auf Anfrage / on request / sur demande

SG	b1	a1	C1 D	C2 D	a2	b3	e1	e3	Ød1
SG-50-C1/ SG-5-C2	156	156	27 / 37	27 / 37	48	102	100	128	20
		196	27 / 37	27 / 37	88	102	140	128	20
		246	27 / 37	27 / 37	138	102	190	128	20
		311	27 / 37	27 / 37	203	102	255	128	20
	196	196	27 / 37	27 / 37	74	135	132	164	25
		246	27 / 37	27 / 37	124	135	182	164	25
		311	27 / 37	27 / 37	189	135	247	164	25
		396	27 / 37	27 / 37	274	135	332	164	25
		496	37 / 47	37 / 47	360	128	424	160	32
		626	37 / 47	37 / 47	490	128	554	160	32
	246	246	37 / 47	37 / 47	110	178	174	210	32
		311	37 / 47	37 / 47	175	178	239	210	32
		396	37 / 47	37 / 47	260	178	324	210	32
		496	37 / 47	37 / 47	360	178	424	210	32
		626	47 / 57	47 / 57	470	168	542	204	40
		706	47 / 57	47 / 57	550	168	622	204	40
	311	311	37 / 47	37 / 47	175	243	239	275	32
		396	37 / 47	37 / 47	260	243	324	275	32
		496	47 / 57	47 / 57	340	233	412	269	40
		626	47 / 57	47 / 57	470	233	542	269	40
		706	47 / 57	47 / 57	550	233	622	269	40
		796	47 / 57	47 / 57	640	233	712	269	40
	396	396	47 / 57	47 / 57	240	318	312	354	40
		496	47 / 57	47 / 57	340	318	412	354	40
		626	57 / 67	57 / 67	448	307	530	348	50
		706	57 / 67	57 / 67	528	307	610	348	50
		796	57 / 67	57 / 67	618	307	700	348	50
	496	496	57 / 67	57 / 67	318	407	400	448	50
626		57 / 67	57 / 67	448	407	530	448	50	
706		57 / 67	57 / 67	528	407	610	448	50	
796		57 / 67	57 / 67	618	407	700	448	50	
626	626	57 / 67	57 / 67	448	537	530	578	50	
	706	57 / 67	57 / 67	528	537	610	578	50	
	796	57 / 67	57 / 67	618	537	700	578	50	

**Combi-Säulengestelle  
mit unten stehenden Säulen**

**Combi-die sets  
with down-mounted columns**

**Combi-blocs à colonnes  
avec colonnes montées en bas**

**Auswahl Gestellplatten**

**Selection die set plates**

**Sélection des plaques de bloc à colonnes**



siehe Seite  
see page 4.60  
voir page

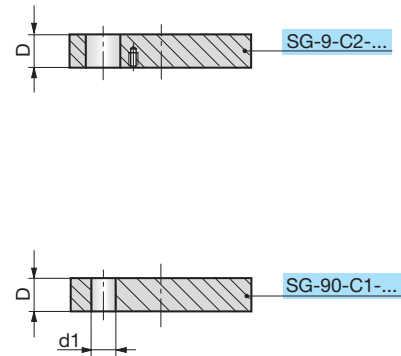
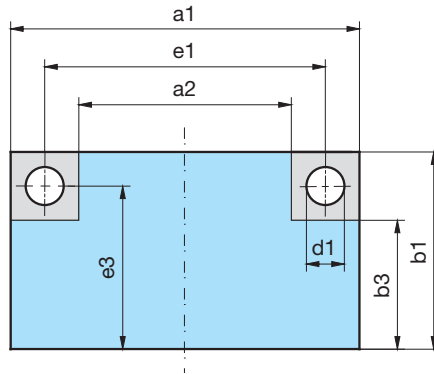

SG-90-C1-  
b1-a1-D-Mat

Mat.: 1.1730/C45W

Mat.: 3.4365 (AL)  
auf Anfrage / on request / sur demande

SG	b1	a1	C1 D	C2 D	a2	b3	e1	e3	Ød1
SG-90-C1/ SG-9-C2	156	156	27 / 37	37	58	107	100	128	20
		196	27 / 37	37	98	107	140	128	20
		246	27 / 37	37	148	107	190	128	20
		311	27 / 37	37	213	107	255	128	20
	196	196	27 / 37	37	84	140	132	164	25
		246	27 / 37	37	134	140	182	164	25
		311	27 / 37	37	199	140	247	164	25
		396	27 / 37	37	284	140	332	164	25
		496	37 / 47	47	368	132	424	160	32
		626	37 / 47	47	498	132	554	160	32
	246	246	37 / 47	47	118	182	174	210	32
		311	37 / 47	47	183	182	239	210	32
		396	37 / 47	47	268	182	324	210	32
		496	37 / 47	47	368	182	424	210	32
		626	47 / 57	47 / 57	474	170	542	204	40
		706	47 / 57	47 / 57	554	170	622	204	40
	311	311	37 / 47	47	183	247	239	275	32
		396	37 / 47	47	268	247	324	275	32
		496	47 / 57	47 / 57	344	235	412	269	40
		626	47 / 57	47 / 57	474	235	542	269	40
		706	47 / 57	47 / 57	554	235	622	269	40
		796	47 / 57	47 / 57	644	235	712	269	40
	396	396	47 / 57	47 / 57	244	320	312	354	40
		496	47 / 57	47 / 57	344	320	412	354	40
		626	57 / 67	57 / 67	452	309	530	348	50
		706	57 / 67	57 / 67	532	309	610	348	50
		796	57 / 67	57 / 67	622	309	700	348	50
	496	496	57 / 67	57 / 67	322	409	400	448	50
626		57 / 67	57 / 67	452	409	530	448	50	
706		57 / 67	57 / 67	532	409	610	448	50	
796		57 / 67	57 / 67	622	409	700	448	50	
626	626	57 / 67	57 / 67	452	539	530	578	50	
	706	57 / 67	57 / 67	532	539	610	578	50	
	796	57 / 67	57 / 67	622	539	700	578	50	

**Combi-Säulengestelle  
mit unten stehenden Säulen**

**Combi-die sets  
with down-mounted columns**

**Combi-blocs à colonnes  
avec colonnes montées en bas**

**Auswahl Gestellplatten**

**Selection die set plates**

**Sélection des plaques de bloc à colonnes**



siehe Seite  
see page 4.62  
voir page

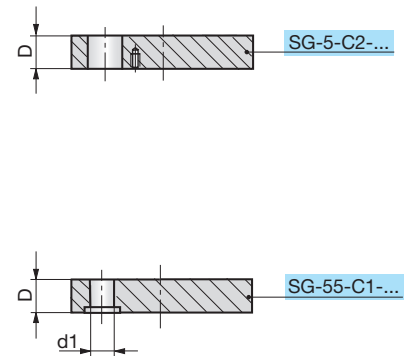
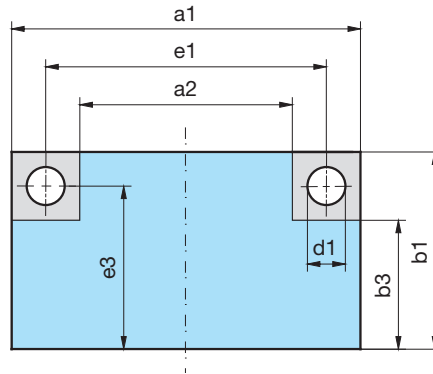

4



SG-55-C1-  
b1-a1-D-Mat

Mat.: 1.1730/C45W

Mat.: 3.4365 (AL)  
auf Anfrage / on request / sur demande

SG	b1	a1	C1 D	C2 D	a2	b3	e1	e3	Ød1
SG-55-C1/ SG-5-C2	156	156	37	27 / 37	48	102	100	128	20
		196	37	27 / 37	88	102	140	128	20
		246	37	27 / 37	138	102	190	128	20
		311	37	27 / 37	203	102	255	128	20
	196	196	37	27 / 37	74	135	132	164	25
		246	37	27 / 37	124	135	182	164	25
		311	37	27 / 37	189	135	247	164	25
		396	37	27 / 37	274	135	332	164	25
		496	47	37 / 47	360	128	424	160	32
		626	47	37 / 47	490	128	554	160	32
	246	246	47	37 / 47	110	178	174	210	32
		311	47	37 / 47	175	178	239	210	32
		396	47	37 / 47	260	178	324	210	32
		496	47	37 / 47	360	178	424	210	32
		626	47 / 57	47 / 57	470	168	542	204	40
		706	47 / 57	47 / 57	550	168	622	204	40
	311	311	47	37 / 47	175	243	239	275	32
		396	47	37 / 47	260	243	324	275	32
		496	47 / 57	47 / 57	340	233	412	269	40
		626	47 / 57	47 / 57	470	233	542	269	40
		706	47 / 57	47 / 57	550	233	622	269	40
		796	47 / 57	47 / 57	640	233	712	269	40
	396	396	47 / 57	47 / 57	240	318	312	354	40
		496	47 / 57	47 / 57	340	318	412	354	40
		626	57 / 67	57 / 67	448	307	530	348	50
		706	57 / 67	57 / 67	528	307	610	348	50
		796	57 / 67	57 / 67	618	307	700	348	50
	496	496	57 / 67	57 / 67	318	407	400	448	50
626		57 / 67	57 / 67	448	407	530	448	50	
706		57 / 67	57 / 67	528	407	610	448	50	
796		57 / 67	57 / 67	618	407	700	448	50	
626	626	57 / 67	57 / 67	448	537	530	578	50	
	706	57 / 67	57 / 67	528	537	610	578	50	
	796	57 / 67	57 / 67	618	537	700	578	50	

**Combi-Säulengestelle  
mit unten stehenden Säulen**

**Combi-die sets  
with down-mounted columns**

**Combi-blocs à colonnes  
avec colonnes montées en bas**

**Auswahl Gestellplatten**

**Selection die set plates**

**Sélection des plaques de bloc à colonnes**

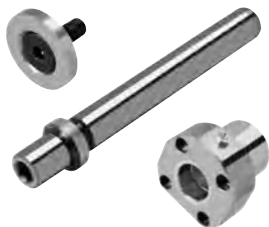

siehe Seite  
see page 4.64  
voir page

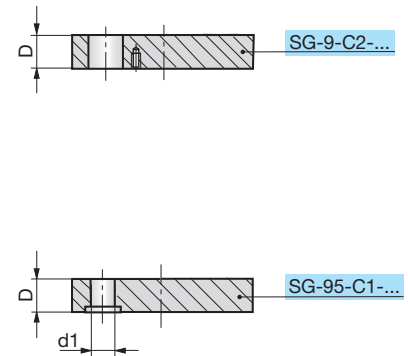
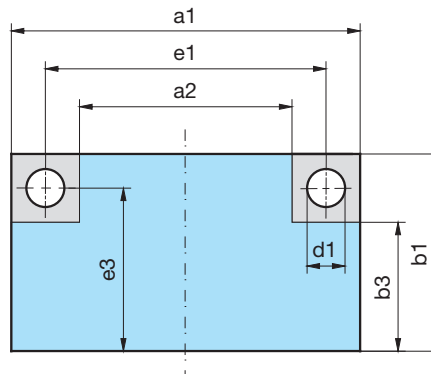

SG-95-C1-  
b1-a1-D-Mat

Mat.: 1.1730/C45W

Mat.: 3.4365 (AL)  
auf Anfrage / on request / sur demande

SG	b1	a1	C1 D	C2 D	a2	b3	e1	e3	Ød1
SG-95-C1/ SG-9-C2	156	156	37	37	58	107	100	128	20
		196	37	37	98	107	140	128	20
		246	37	37	148	107	190	128	20
		311	37	37	213	107	255	128	20
	196	196	37	37	84	140	132	164	25
		246	37	37	134	140	182	164	25
		311	37	37	199	140	247	164	25
		396	37	37	284	140	332	164	25
		496	47	47	368	132	424	160	32
		626	47	47	498	132	554	160	32
	246	246	47	47	118	182	174	210	32
		311	47	47	183	182	239	210	32
		396	47	47	268	182	324	210	32
		496	47	47	368	182	424	210	32
		626	47 / 57	47 / 57	474	170	542	204	40
		706	47 / 57	47 / 57	554	170	622	204	40
	311	311	47	47	183	247	239	275	32
		396	47	47	268	247	324	275	32
		496	47 / 57	47 / 57	344	235	412	269	40
		626	47 / 57	47 / 57	474	235	542	269	40
		706	47 / 57	47 / 57	554	235	622	269	40
		796	47 / 57	47 / 57	644	235	712	269	40
	396	396	47 / 57	47 / 57	244	320	312	354	40
		496	47 / 57	47 / 57	344	320	412	354	40
		626	57 / 67	57 / 67	452	309	530	348	50
		706	57 / 67	57 / 67	532	309	610	348	50
		796	57 / 67	57 / 67	622	309	700	348	50
	496	496	57 / 67	57 / 67	322	409	400	448	50
626		57 / 67	57 / 67	452	409	530	448	50	
706		57 / 67	57 / 67	532	409	610	448	50	
796		57 / 67	57 / 67	622	409	700	448	50	
626	626	57 / 67	57 / 67	452	539	530	578	50	
	706	57 / 67	57 / 67	532	539	610	578	50	
	796	57 / 67	57 / 67	622	539	700	578	50	

**Combi-Säulengestelle  
mit unten stehenden Säulen**

**Combi-die sets  
with down-mounted columns**

**Combi-blocs à colonnes  
avec colonnes montées en bas**

**Auswahl Gestellplatten**

**Selection die set plates**

**Sélection des plaques de bloc à colonnes**



siehe Seite  
see page 4.66  
voir page

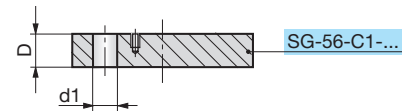
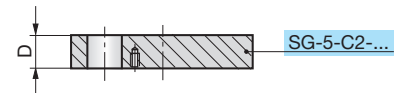
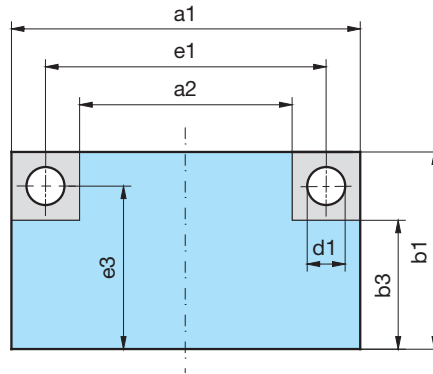

SG-56-C1-  
b1-a1-D-Mat

Mat.: 1.1730/C45W

Mat.: 3.4365 (AL)  
auf Anfrage / on request / sur demande

SG	b1	a1	C1 D	C2 D	a2	b3	e1	e3	Ød1
SG-56-C1/ SG-5-C2	156	156	27 / 37	27 / 37	48	102	100	128	20
		196	27 / 37	27 / 37	88	102	140	128	20
		246	27 / 37	27 / 37	138	102	190	128	20
		311	27 / 37	27 / 37	203	102	255	128	20
	196	196	27 / 37	27 / 37	74	135	132	164	25
		246	27 / 37	27 / 37	124	135	182	164	25
		311	27 / 37	27 / 37	189	135	247	164	25
		396	27 / 37	27 / 37	274	135	332	164	25
		496	37 / 47	37 / 47	360	128	424	160	32
		626	37 / 47	37 / 47	490	128	554	160	32
	246	246	37 / 47	37 / 47	110	178	174	210	32
		311	37 / 47	37 / 47	175	178	239	210	32
		396	37 / 47	37 / 47	260	178	324	210	32
		496	37 / 47	37 / 47	360	178	424	210	32
		626	47 / 57	47 / 57	470	168	542	204	40
		706	47 / 57	47 / 57	550	168	622	204	40
	311	311	37 / 47	37 / 47	175	243	239	275	32
		396	37 / 47	37 / 47	260	243	324	275	32
		496	47 / 57	47 / 57	340	233	412	269	40
		626	47 / 57	47 / 57	470	233	542	269	40
		706	47 / 57	47 / 57	550	233	622	269	40
		796	47 / 57	47 / 57	640	233	712	269	40
	396	396	47 / 57	47 / 57	240	318	312	354	40
		496	47 / 57	47 / 57	340	318	412	354	40
		626	57 / 67	57 / 67	448	307	530	348	50
		706	57 / 67	57 / 67	528	307	610	348	50
		796	57 / 67	57 / 67	618	307	700	348	50
	496	496	57 / 67	57 / 67	318	407	400	448	50
626		57 / 67	57 / 67	448	407	530	448	50	
706		57 / 67	57 / 67	528	407	610	448	50	
796		57 / 67	57 / 67	618	407	700	448	50	
626	626	57 / 67	57 / 67	448	537	530	578	50	
	706	57 / 67	57 / 67	528	537	610	578	50	
	796	57 / 67	57 / 67	618	537	700	578	50	



**Combi-Säulengestelle  
mit unten stehenden Säulen**

**Combi-die sets  
with down-mounted columns**

**Combi-blocs à colonnes  
avec colonnes montées en bas**

**Auswahl Gestellplatten**

**Selection die set plates**

**Sélection des plaques de bloc à colonnes**

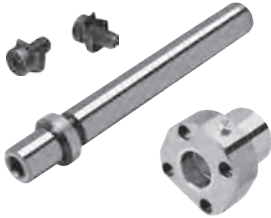

siehe Seite  
see page 4.68  
voir page

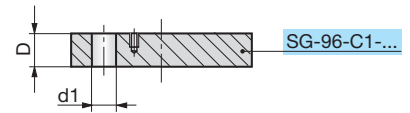
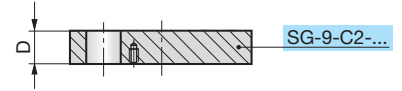
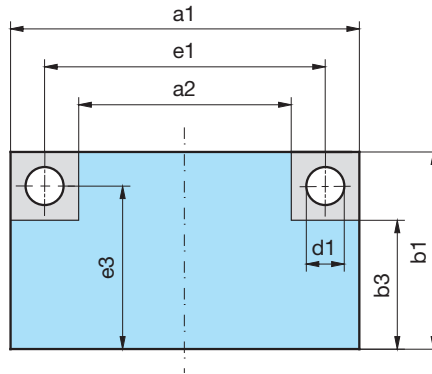

SG-96-C1-  
b1-a1-D-Mat

Mat.: 1.1730/C45W

Mat.: 3.4365 (AL)  
auf Anfrage / on request / sur demande

SG	b1	a1	C1 D	C2 D	a2	b3	e1	e3	Ød1
SG-96-C1/ SG-9-C2	156	156	27 / 37	37	58	107	100	128	20
		196	27 / 37	37	98	107	140	128	20
		246	27 / 37	37	148	107	190	128	20
		311	27 / 37	37	213	107	255	128	20
	196	196	27 / 37	37	84	140	132	164	25
		246	27 / 37	37	134	140	182	164	25
		311	27 / 37	37	199	140	247	164	25
		396	27 / 37	37	284	140	332	164	25
		496	37 / 47	47	368	132	424	160	32
		626	37 / 47	47	498	132	554	160	32
	246	246	37 / 47	47	118	182	174	210	32
		311	37 / 47	47	183	182	239	210	32
		396	37 / 47	47	268	182	324	210	32
		496	37 / 47	47	368	182	424	210	32
		626	47 / 57	47 / 57	474	170	542	204	40
		706	47 / 57	47 / 57	554	170	622	204	40
	311	311	37 / 47	47	183	247	239	275	32
		396	37 / 47	47	268	247	324	275	32
		496	47 / 57	47 / 57	344	235	412	269	40
		626	47 / 57	47 / 57	474	235	542	269	40
		706	47 / 57	47 / 57	554	235	622	269	40
		796	47 / 57	47 / 57	644	235	712	269	40
	396	396	47 / 57	47 / 57	244	320	312	354	40
		496	47 / 57	47 / 57	344	320	412	354	40
		626	57 / 67	57 / 67	452	309	530	348	50
		706	57 / 67	57 / 67	532	309	610	348	50
		796	57 / 67	57 / 67	622	309	700	348	50
	496	496	57 / 67	57 / 67	322	409	400	448	50
626		57 / 67	57 / 67	452	409	530	448	50	
706		57 / 67	57 / 67	532	409	610	448	50	
796		57 / 67	57 / 67	622	409	700	448	50	
626	626	57 / 67	57 / 67	452	539	530	578	50	
	706	57 / 67	57 / 67	532	539	610	578	50	
	796	57 / 67	57 / 67	622	539	700	578	50	

**Combi-Säulengestelle  
mit oben hängenden Säulen**

**Combi-die sets  
with aerial-mounted columns**

**Combi-blocs à colonnes  
avec colonnes montées en haut**

**Auswahl Gestellplatten**

**Selection die set plates**

**Sélection des plaques de bloc à colonnes**



siehe Seite  
see page 4.58  
voir page

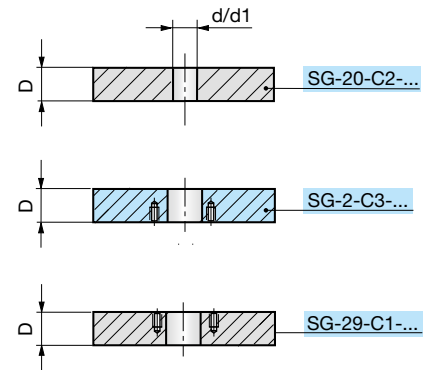
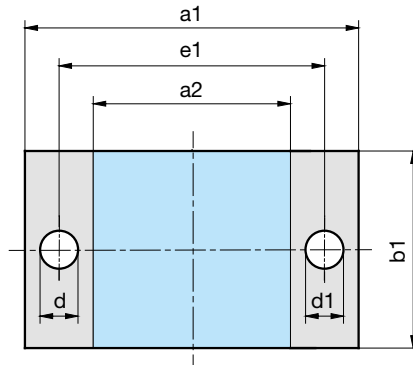

4



SG-29-C1-  
b1-a1-D-Mat

Mat.: 1.1730/C45W

Mat.: 3.4365 (AL)  
auf Anfrage / on request / sur demande

SG	b1	a1	C1 D	C2 D	C3 D	a2	e1	Ød	Ød1
SG-29-C1/ SG-20-C2/ SG-2-C3	156	156	27 / 37	27 / 37	27	48	100	19	20
		196	27 / 37	27 / 37	27	88	140	19	20
		246	27 / 37	27 / 37	27	138	190	19	20
		311	27 / 37	27 / 37	27	203	255	19	20
	196	196	27 / 37	27 / 37	27	74	132	24	25
		246	27 / 37	27 / 37	27	124	182	24	25
		311	27 / 37	27 / 37	27	189	247	24	25
		396	27 / 37	27 / 37	27	274	332	24	25
		496	37 / 47	37 / 47	27	360	424	30	32
		626	37 / 47	37 / 47	27	490	554	30	32
	246	246	37 / 47	37 / 47	27	110	174	30	32
		311	37 / 47	37 / 47	27	175	239	30	32
		396	37 / 47	37 / 47	27	260	324	30	32
		496	37 / 47	37 / 47	27	360	424	30	32
		626	47 / 57	47 / 57	27	470	542	38	40
		706	47 / 57	47 / 57	27	550	622	38	40
	311	311	37 / 47	37 / 47	27	175	239	30	32
		396	37 / 47	37 / 47	27	260	324	30	32
		496	47 / 57	47 / 57	27	340	412	38	40
		626	47 / 57	47 / 57	27	470	542	38	40
		706	47 / 57	47 / 57	27	550	622	38	40
		796	47 / 57	47 / 57	27	640	712	38	40
	396	396	47 / 57	47 / 57	37	240	312	38	40
		496	47 / 57	47 / 57	37	340	412	38	40
626		57 / 67	57 / 67	37	448	530	48	50	
706		57 / 67	57 / 67	37	528	610	48	50	
796		57 / 67	57 / 67	37	618	700	48	50	
496	496	57 / 67	57 / 67	37	318	400	48	50	
	626	57 / 67	57 / 67	37	448	530	48	50	
	706	57 / 67	57 / 67	37	528	610	48	50	
	796	57 / 67	57 / 67	37	618	700	48	50	
626	626	57 / 67	57 / 67	37	448	530	48	50	
	706	57 / 67	57 / 67	37	528	610	48	50	
	796	57 / 67	57 / 67	37	618	700	48	50	

**Combi-Säulengestelle  
mit oben hängenden Säulen**

**Combi-die sets  
with aerial-mounted columns**

**Combi-blocs à colonnes  
avec colonnes montées en haut**

**Auswahl Gestellplatten**

**Selection die set plates**

**Sélection des plaques de bloc à colonnes**



siehe Seite  
see page **4.60**  
voir page

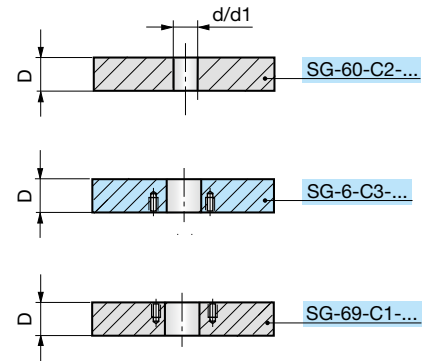
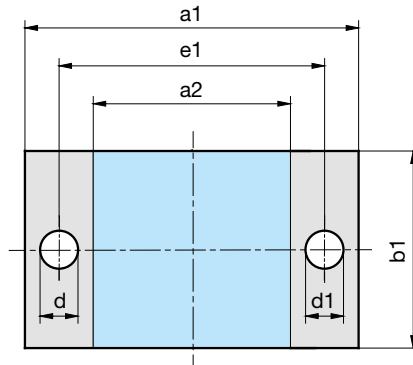

SG-69-C1-  
b1-a1-D-Mat

Mat.: 1.1730/C45W

Mat.: 3.4365 (AL)  
auf Anfrage / on request / sur demande

SG	b1	a1	C1 D	C2 D	C3 D	a2	e1	Ød	Ød1
SG-69-C1/ SG-60-C2/ SG-6-C3	156	156	37	27 / 37	27	58	100	19	20
		196	37	27 / 37	27	98	140	19	20
		246	37	27 / 37	27	148	190	19	20
		311	37	27 / 37	27	213	255	19	20
	196	196	37	27 / 37	27	84	132	24	25
		246	37	27 / 37	27	134	182	24	25
		311	37	27 / 37	27	199	247	24	25
		396	37	27 / 37	27	284	332	24	25
		496	47	37 / 47	27	368	424	30	32
		626	47	37 / 47	27	498	554	30	32
	246	246	47	37 / 47	27	118	174	30	32
		311	47	37 / 47	27	183	239	30	32
		396	47	37 / 47	27	268	324	30	32
		496	47	37 / 47	27	368	424	30	32
		626	47 / 57	47 / 57	27	474	542	38	40
		706	47 / 57	47 / 57	27	554	622	38	40
	311	311	47	37 / 47	27	183	239	30	32
		396	47	37 / 47	27	268	324	30	32
		496	47 / 57	47 / 57	27	344	412	38	40
		626	47 / 57	47 / 57	27	474	542	38	40
		706	47 / 57	47 / 57	27	554	622	38	40
		796	47 / 57	47 / 57	27	644	712	38	40
	396	396	47 / 57	47 / 57	37	244	312	38	40
		496	47 / 57	47 / 57	37	344	412	38	40
626		57 / 67	57 / 67	37	452	530	48	50	
706		57 / 67	57 / 67	37	532	610	48	50	
796		57 / 67	57 / 67	37	622	700	48	50	
496	496	57 / 67	57 / 67	37	322	400	48	50	
	626	57 / 67	57 / 67	37	452	530	48	50	
	706	57 / 67	57 / 67	37	532	610	48	50	
	796	57 / 67	57 / 67	37	622	700	48	50	
626	626	57 / 67	57 / 67	37	452	530	48	50	
	706	57 / 67	57 / 67	37	532	610	48	50	
	796	57 / 67	57 / 67	37	622	700	48	50	

**Combi-Säulengestelle  
mit oben hängenden Säulen**

**Combi-die sets  
with aerial-mounted columns**

**Combi-blocs à colonnes  
avec colonnes montées en haut**

**Auswahl Gestellplatten**

**Selection die set plates**

**Sélection des plaques de bloc à colonnes**



siehe Seite  
see page 4.62  
voir page

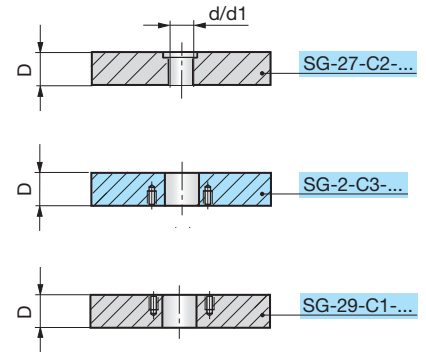
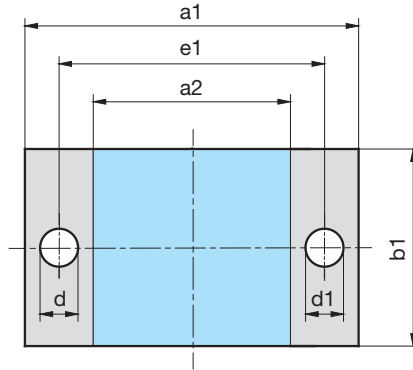

4



SG-29-C1-  
b1-a1-D-Mat

Mat.: 1.1730/C45W

Mat.: 3.4365 (AL)  
auf Anfrage / on request / sur demande

SG	b1	a1	C1 D	C2 D	C3 D	a2	e1	Ød	Ød1
SG-29-C1/ SG-27-C2/ SG-2-C3	156	156	27 / 37	37	27	48	100	19	20
		196	27 / 37	37	27	88	140	19	20
		246	27 / 37	37	27	138	190	19	20
		311	27 / 37	37	27	203	255	19	20
	196	196	27 / 37	37	27	74	132	24	25
		246	27 / 37	37	27	124	182	24	25
		311	27 / 37	37	27	189	247	24	25
		396	27 / 37	37	27	274	332	24	25
		496	37 / 47	47	27	360	424	30	32
		626	37 / 47	47	27	490	554	30	32
	246	246	37 / 47	47	27	110	174	30	32
		311	37 / 47	47	27	175	239	30	32
		396	37 / 47	47	27	260	324	30	32
		496	37 / 47	47	27	360	424	30	32
		626	47 / 57	47 / 57	27	470	542	38	40
		706	47 / 57	47 / 57	27	550	622	38	40
	311	311	37 / 47	47	27	175	239	30	32
		396	37 / 47	47	27	260	324	30	32
		496	47 / 57	47 / 57	27	340	412	38	40
		626	47 / 57	47 / 57	27	470	542	38	40
		706	47 / 57	47 / 57	27	550	622	38	40
		796	47 / 57	47 / 57	27	640	712	38	40
	396	396	47 / 57	47 / 57	37	240	312	38	40
		496	47 / 57	47 / 57	37	340	412	38	40
626		57 / 67	57 / 67	37	448	530	48	50	
706		57 / 67	57 / 67	37	528	610	48	50	
796		57 / 67	57 / 67	37	618	700	48	50	
496	496	57 / 67	57 / 67	37	318	400	48	50	
	626	57 / 67	57 / 67	37	448	530	48	50	
	706	57 / 67	57 / 67	37	528	610	48	50	
	796	57 / 67	57 / 67	37	618	700	48	50	
626	626	57 / 67	57 / 67	37	448	530	48	50	
	706	57 / 67	57 / 67	37	528	610	48	50	
	796	57 / 67	57 / 67	37	618	700	48	50	

**Combi-Säulengestelle  
mit oben hängenden Säulen**

**Combi-die sets  
with aerial-mounted columns**

**Combi-blocs à colonnes  
avec colonnes montées en haut**

**Auswahl Gestellplatten**

**Selection die set plates**

**Sélection des plaques de bloc à colonnes**

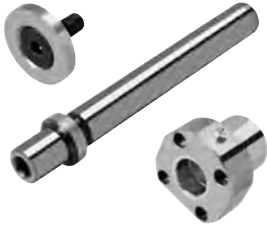

siehe Seite  
see page 4.64  
voir page

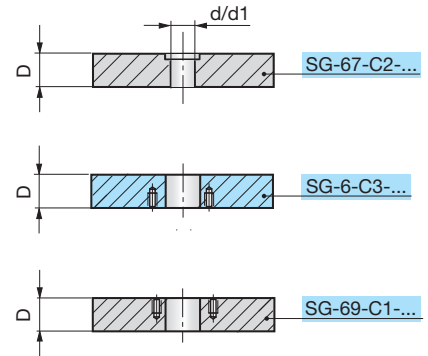
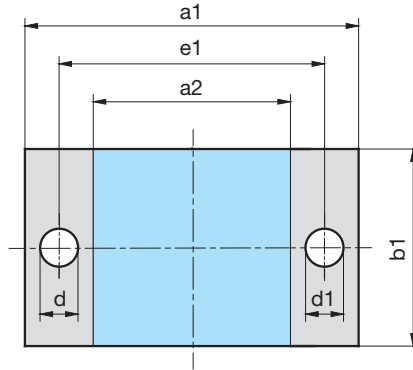

SG-69-C1-  
b1-a1-D-Mat

Mat.: 1.1730/C45W

Mat.: 3.4365 (AL)  
auf Anfrage / on request / sur demande

SG	b1	a1	C1 D	C2 D	C3 D	a2	e1	Ød	Ød1
SG-69-C1/ SG-67-C2/ SG-6-C3	156	156	37	37	27	58	100	19	20
		196	37	37	27	98	140	19	20
		246	37	37	27	148	190	19	20
		311	37	37	27	213	255	19	20
	196	196	37	37	27	84	132	24	25
		246	37	37	27	134	182	24	25
		311	37	37	27	199	247	24	25
		396	37	37	27	284	332	24	25
		496	47	47	27	368	424	30	32
		626	47	47	27	498	554	30	32
	246	246	47	47	27	118	174	30	32
		311	47	47	27	183	239	30	32
		396	47	47	27	268	324	30	32
		496	47	47	27	368	424	30	32
		626	47 / 57	47 / 57	27	474	542	38	40
		706	47 / 57	47 / 57	27	554	622	38	40
	311	311	47	47	27	183	239	30	32
		396	47	47	27	268	324	30	32
		496	47 / 57	47 / 57	27	344	412	38	40
		626	47 / 57	47 / 57	27	474	542	38	40
		706	47 / 57	47 / 57	27	554	622	38	40
		796	47 / 57	47 / 57	27	644	712	38	40
	396	396	47 / 57	47 / 57	37	244	312	38	40
		496	47 / 57	47 / 57	37	344	412	38	40
626		57 / 67	57 / 67	37	452	530	48	50	
706		57 / 67	57 / 67	37	532	610	48	50	
796		57 / 67	57 / 67	37	622	700	48	50	
496	496	57 / 67	57 / 67	37	322	400	48	50	
	626	57 / 67	57 / 67	37	452	530	48	50	
	706	57 / 67	57 / 67	37	532	610	48	50	
	796	57 / 67	57 / 67	37	622	700	48	50	
626	626	57 / 67	57 / 67	37	452	530	48	50	
	706	57 / 67	57 / 67	37	532	610	48	50	
	796	57 / 67	57 / 67	37	622	700	48	50	

**Combi-Säulengestelle  
mit oben hängenden Säulen**

**Combi-die sets  
with aerial-mounted columns**

**Combi-blocs à colonnes  
avec colonnes montées en haut**

**Auswahl Gestellplatten**

**Selection die set plates**

**Sélection des plaques de bloc à colonnes**



siehe Seite  
see page 4.66  
voir page

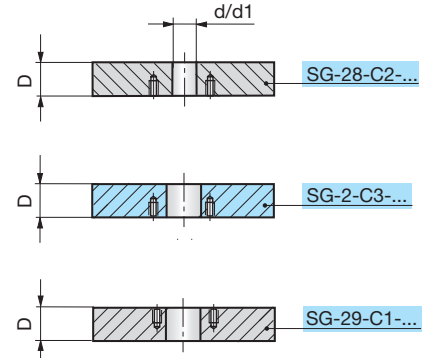
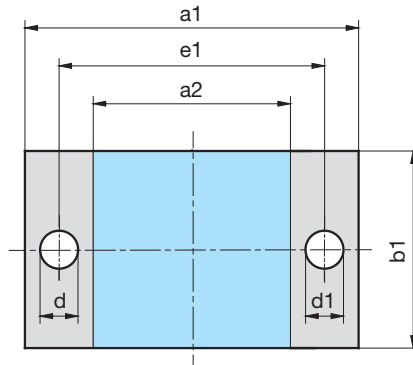

SG-29-C1-  
b1-a1-D-Mat

Mat.: 1.1730/C45W

Mat.: 3.4365 (AL)  
auf Anfrage / on request / sur demande

SG	b1	a1	C1 D	C2 D	C3 D	a2	e1	Ød	Ød1
SG-29-C1/ SG-28-C2/ SG-2-C3	156	156	27 / 37	27 / 37	27	48	100	19	20
		196	27 / 37	27 / 37	27	88	140	19	20
		246	27 / 37	27 / 37	27	138	190	19	20
		311	27 / 37	27 / 37	27	203	255	19	20
	196	196	27 / 37	27 / 37	27	74	132	24	25
		246	27 / 37	27 / 37	27	124	182	24	25
		311	27 / 37	27 / 37	27	189	247	24	25
		396	27 / 37	27 / 37	27	274	332	24	25
		496	37 / 47	37 / 47	27	360	424	30	32
	246	626	37 / 47	37 / 47	27	490	554	30	32
		246	37 / 47	37 / 47	27	110	174	30	32
		311	37 / 47	37 / 47	27	175	239	30	32
		396	37 / 47	37 / 47	27	260	324	30	32
		496	37 / 47	37 / 47	27	360	424	30	32
		626	47 / 57	47 / 57	27	470	542	38	40
	311	706	47 / 57	47 / 57	27	550	622	38	40
		311	37 / 47	37 / 47	27	175	239	30	32
		396	37 / 47	37 / 47	27	260	324	30	32
		496	47 / 57	47 / 57	27	340	412	38	40
		626	47 / 57	47 / 57	27	470	542	38	40
		706	47 / 57	47 / 57	27	550	622	38	40
	396	796	47 / 57	47 / 57	27	640	712	38	40
		396	47 / 57	47 / 57	37	240	312	38	40
		496	47 / 57	47 / 57	37	340	412	38	40
626		57 / 67	57 / 67	37	448	530	48	50	
706		57 / 67	57 / 67	37	528	610	48	50	
496	796	57 / 67	57 / 67	37	618	700	48	50	
	496	57 / 67	57 / 67	37	318	400	48	50	
	626	57 / 67	57 / 67	37	448	530	48	50	
	706	57 / 67	57 / 67	37	528	610	48	50	
626	796	57 / 67	57 / 67	37	618	700	48	50	
	626	57 / 67	57 / 67	37	448	530	48	50	
	706	57 / 67	57 / 67	37	528	610	48	50	
		796	57 / 67	57 / 67	37	618	700	48	50

**Combi-Säulengestelle  
mit oben hängenden Säulen**

**Combi-die sets  
with aerial-mounted columns**

**Combi-blocs à colonnes  
avec colonnes montées en haut**

**Auswahl Gestellplatten**

**Selection die set plates**

**Sélection des plaques de bloc à colonnes**

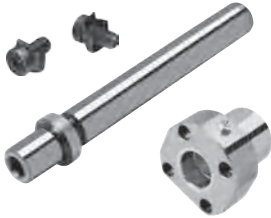

siehe Seite  
see page **4.68**  
voir page

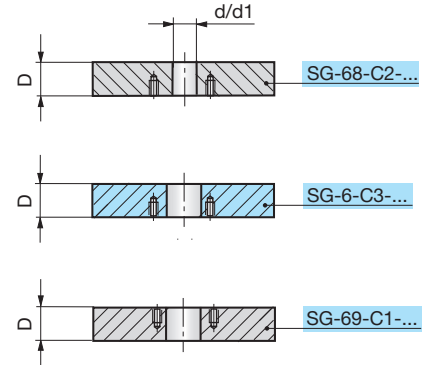
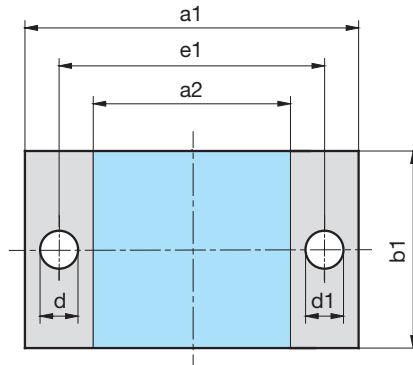

SG-69-C1-  
b1-a1-D-Mat

Mat.: 1.1730/C45W

Mat.: 3.4365 (AL)  
auf Anfrage / on request / sur demande

SG	b1	a1	C1 D	C2 D	C3 D	a2	e1	Ød	Ød1
SG-69-C1/ SG-68-C2/ SG-6-C3	156	156	37	27 / 37	27	58	100	19	20
		196	37	27 / 37	27	98	140	19	20
		246	37	27 / 37	27	148	190	19	20
		311	37	27 / 37	27	213	255	19	20
	196	196	37	27 / 37	27	84	132	24	25
		246	37	27 / 37	27	134	182	24	25
		311	37	27 / 37	27	199	247	24	25
		396	37	27 / 37	27	284	332	24	25
		496	47	37 / 47	27	368	424	30	32
		626	47	37 / 47	27	498	554	30	32
	246	246	47	37 / 47	27	118	174	30	32
		311	47	37 / 47	27	183	239	30	32
		396	47	37 / 47	27	268	324	30	32
		496	47	37 / 47	27	368	424	30	32
		626	47 / 57	47 / 57	27	474	542	38	40
		706	47 / 57	47 / 57	27	554	622	38	40
	311	311	47	37 / 47	27	183	239	30	32
		396	47	37 / 47	27	268	324	30	32
		496	47 / 57	47 / 57	27	344	412	38	40
		626	47 / 57	47 / 57	27	474	542	38	40
		706	47 / 57	47 / 57	27	554	622	38	40
		796	47 / 57	47 / 57	27	644	712	38	40
	396	396	47 / 57	47 / 57	37	244	312	38	40
		496	47 / 57	47 / 57	37	344	412	38	40
626		57 / 67	57 / 67	37	452	530	48	50	
706		57 / 67	57 / 67	37	532	610	48	50	
796		57 / 67	57 / 67	37	622	700	48	50	
496	496	57 / 67	57 / 67	37	322	400	48	50	
	626	57 / 67	57 / 67	37	452	530	48	50	
	706	57 / 67	57 / 67	37	532	610	48	50	
	796	57 / 67	57 / 67	37	622	700	48	50	
626	626	57 / 67	57 / 67	37	452	530	48	50	
	706	57 / 67	57 / 67	37	532	610	48	50	
	796	57 / 67	57 / 67	37	622	700	48	50	

**Combi-Säulengestelle  
mit oben hängenden Säulen**

**Combi-die sets  
with aerial-mounted columns**

**Combi-blocs à colonnes  
avec colonnes montées en haut**

**Auswahl Gestellplatten**

**Selection die set plates**

**Sélection des plaques de bloc à colonnes**



siehe Seite  
see page 4.58  
voir page

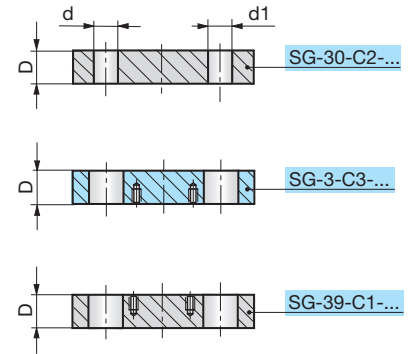
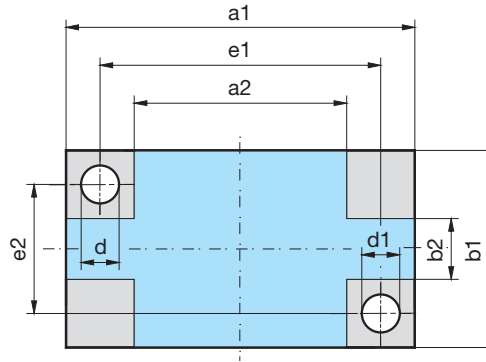

SG-39-C1-  
b1-a1-D-Mat

Mat.: 1.1730/C45W

Mat.: 3.4365 (AL)  
auf Anfrage / on request / sur demande

SG	b1	a1	C1 D	C2 D	C3 D	a2	b2	e1	e2	Ød	Ød1
SG-39-C1/ SG-30-C2/ SG-3-C3	156	156	27 / 37	27 / 37	27	48	48	100	100	19	20
		196	27 / 37	27 / 37	27	88	48	140	100	19	20
		246	27 / 37	27 / 37	27	138	48	190	100	19	20
		311	27 / 37	27 / 37	27	203	48	255	100	19	20
	196	196	27 / 37	27 / 37	27	74	74	132	132	24	25
		246	27 / 37	27 / 37	27	124	74	182	132	24	25
		311	27 / 37	27 / 37	27	189	74	247	132	24	25
		396	27 / 37	27 / 37	27	274	74	332	132	24	25
		496	37 / 47	37 / 47	27	360	60	424	124	30	32
		626	37 / 47	37 / 47	27	490	60	554	124	30	32
	246	246	37 / 47	37 / 47	27	110	110	174	174	30	32
		311	37 / 47	37 / 47	27	175	110	239	174	30	32
		396	37 / 47	37 / 47	27	260	110	324	174	30	32
		496	37 / 47	37 / 47	27	360	110	424	174	30	32
		626	47 / 57	47 / 57	27	470	90	542	162	38	40
		706	47 / 57	47 / 57	27	550	90	622	162	38	40
	311	311	37 / 47	37 / 47	27	175	175	239	239	30	32
		396	37 / 47	37 / 47	27	260	175	324	239	30	32
		496	47 / 57	47 / 57	27	340	155	412	227	38	40
		626	47 / 57	47 / 57	27	470	155	542	227	38	40
706		47 / 57	47 / 57	27	550	155	622	227	38	40	
796		47 / 57	47 / 57	27	640	155	712	227	38	40	
396	396	47 / 57	47 / 57	37	240	240	312	312	38	40	
	496	47 / 57	47 / 57	37	340	240	412	312	38	40	
	626	57 / 67	57 / 67	37	448	218	530	300	48	50	
	706	57 / 67	57 / 67	37	528	218	610	300	48	50	
	796	57 / 67	57 / 67	37	618	218	700	300	48	50	
496	496	57 / 67	57 / 67	37	318	318	400	400	48	50	
	626	57 / 67	57 / 67	37	448	318	530	400	48	50	
	706	57 / 67	57 / 67	37	528	318	610	400	48	50	
	796	57 / 67	57 / 67	37	618	318	700	400	48	50	
626	626	57 / 67	57 / 67	37	448	448	530	530	48	50	
	706	57 / 67	57 / 67	37	528	448	610	530	48	50	
	796	57 / 67	57 / 67	37	618	448	700	530	48	50	



**Combi-Säulengestelle  
mit oben hängenden Säulen**

**Combi-die sets  
with aerial-mounted columns**

**Combi-blocs à colonnes  
avec colonnes montées en haut**

**Auswahl Gestellplatten**

**Selection die set plates**

**Sélection des plaques de bloc à colonnes**



siehe Seite  
see page **4.60**  
voir page

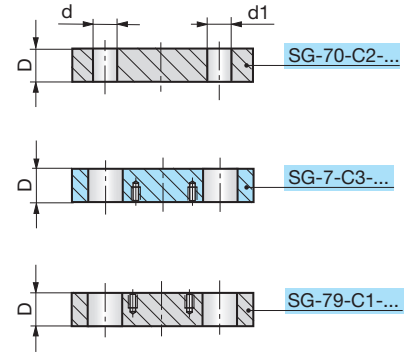
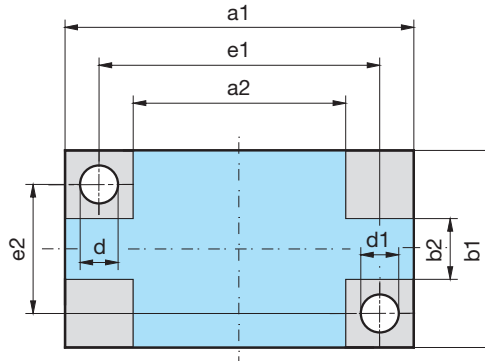

SG-79-C1-  
b1-a1-D-Mat

Mat.: 1.1730/C45W

Mat.: 3.4365 (AL)  
auf Anfrage / on request / sur demande

SG	b1	a1	C1 D	C2 D	C3 D	a2	b2	e1	e2	Ød	Ød1
SG-79-C1/ SG-70-C2/ SG-7-C3	156	156	37	27 / 37	27	58	58	100	100	19	20
		196	37	27 / 37	27	98	58	140	100	19	20
		246	37	27 / 37	27	148	58	190	100	19	20
		311	37	27 / 37	27	213	58	255	100	19	20
	196	196	37	27 / 37	27	84	84	132	132	24	25
		246	37	27 / 37	27	134	84	182	132	24	25
		311	37	27 / 37	27	199	84	247	132	24	25
		396	37	27 / 37	27	284	84	332	132	24	25
		496	47	37 / 47	27	368	68	424	124	30	32
		626	47	37 / 47	27	498	68	554	124	30	32
	246	246	47	37 / 47	27	118	118	174	174	30	32
		311	47	37 / 47	27	183	118	239	174	30	32
		396	47	37 / 47	27	268	118	324	174	30	32
		496	47	37 / 47	27	368	118	424	174	30	32
		626	47 / 57	47 / 57	27	474	94	542	162	38	40
		706	47 / 57	47 / 57	27	554	94	622	162	38	40
	311	311	47	37 / 47	27	183	183	239	239	30	32
		396	47	37 / 47	27	268	183	324	239	30	32
		496	47 / 57	47 / 57	27	344	159	412	227	38	40
		626	47 / 57	47 / 57	27	474	159	542	227	38	40
706		47 / 57	47 / 57	27	554	159	622	227	38	40	
796		47 / 57	47 / 57	27	644	159	712	227	38	40	
396	396	47 / 57	47 / 57	37	244	244	312	312	38	40	
	496	47 / 57	47 / 57	37	344	244	412	312	38	40	
	626	57 / 67	57 / 67	37	452	222	530	300	48	50	
	706	57 / 67	57 / 67	37	532	222	610	300	48	50	
	796	57 / 67	57 / 67	37	622	222	700	300	48	50	
496	496	57 / 67	57 / 67	37	322	224	400	400	48	50	
	626	57 / 67	57 / 67	37	452	224	530	400	48	50	
	706	57 / 67	57 / 67	37	532	224	610	400	48	50	
	796	57 / 67	57 / 67	37	622	322	700	400	48	50	
626	626	57 / 67	57 / 67	37	452	452	530	530	48	50	
	706	57 / 67	57 / 67	37	532	452	610	530	48	50	
	796	57 / 67	57 / 67	37	622	452	700	530	48	50	

**Combi-Säulengestelle  
mit oben hängenden Säulen**

**Combi-die sets  
with aerial-mounted columns**

**Combi-blocs à colonnes  
avec colonnes montées en haut**

**Auswahl Gestellplatten**

**Selection die set plates**

**Sélection des plaques de bloc à colonnes**



siehe Seite  
see page 4.62  
voir page

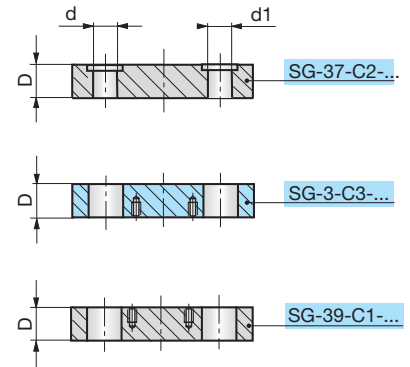
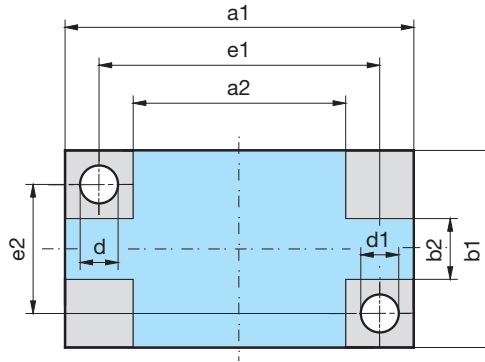

SG-39-C1-  
b1-a1-D-Mat

Mat.: 1.1730/C45W

Mat.: 3.4365 (AL)  
auf Anfrage / on request / sur demande

SG	b1	a1	C1 D	C2 D	C3 D	a2	b2	e1	e2	Ød	Ød1
SG-39-C1/ SG-37-C2/ SG-3-C3	156	156	27 / 37	37	27	48	48	100	100	19	20
		196	27 / 37	37	27	88	48	140	100	19	20
		246	27 / 37	37	27	138	48	190	100	19	20
		311	27 / 37	37	27	203	48	255	100	19	20
	196	196	27 / 37	37	27	74	74	132	132	24	25
		246	27 / 37	37	27	124	74	182	132	24	25
		311	27 / 37	37	27	189	74	247	132	24	25
		396	27 / 37	37	27	274	74	332	132	24	25
		496	37 / 47	47	27	360	60	424	124	30	32
		626	37 / 47	47	27	490	60	554	124	30	32
	246	246	37 / 47	47	27	110	110	174	174	30	32
		311	37 / 47	47	27	175	110	239	174	30	32
		396	37 / 47	47	27	260	110	324	174	30	32
		496	37 / 47	47	27	360	110	424	174	30	32
		626	47 / 57	47 / 57	27	470	90	542	162	38	40
		706	47 / 57	47 / 57	27	550	90	622	162	38	40
	311	311	37 / 47	47	27	175	175	239	239	30	32
		396	37 / 47	47	27	260	175	324	239	30	32
		496	47 / 57	47 / 57	27	340	155	412	227	38	40
		626	47 / 57	47 / 57	27	470	155	542	227	38	40
		706	47 / 57	47 / 57	27	550	155	622	227	38	40
		796	47 / 57	47 / 57	27	640	155	712	227	38	40
	396	396	47 / 57	47 / 57	37	240	240	312	312	38	40
		496	47 / 57	47 / 57	37	340	240	412	312	38	40
626		57 / 67	57 / 67	37	448	218	530	300	48	50	
706		57 / 67	57 / 67	37	528	218	610	300	48	50	
796		57 / 67	57 / 67	37	618	218	700	300	48	50	
496	496	57 / 67	57 / 67	37	318	318	400	400	48	50	
	626	57 / 67	57 / 67	37	448	318	530	400	48	50	
	706	57 / 67	57 / 67	37	528	318	610	400	48	50	
	796	57 / 67	57 / 67	37	618	318	700	400	48	50	
626	626	57 / 67	57 / 67	37	448	448	530	530	48	50	
	706	57 / 67	57 / 67	37	528	448	610	530	48	50	
	796	57 / 67	57 / 67	37	618	448	700	530	48	50	

**Combi-Säulengestelle  
mit oben hängenden Säulen**

**Combi-die sets  
with aerial-mounted columns**

**Combi-blocs à colonnes  
avec colonnes montées en haut**

**Auswahl Gestellplatten**

**Selection die set plates**

**Sélection des plaques de bloc à colonnes**

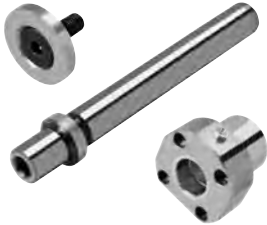

siehe Seite  
see page 4.64  
voir page

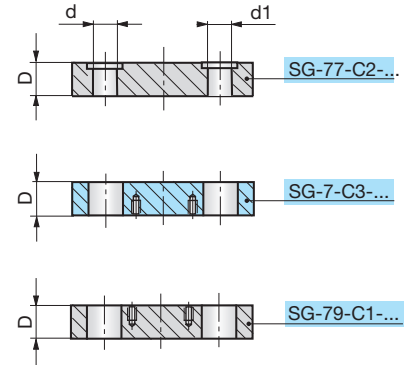
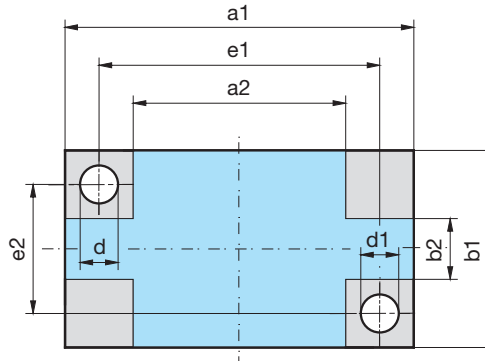

SG-79-C1-  
b1-a1-D-Mat

Mat.: 1.1730/C45W

Mat.: 3.4365 (AL)  
auf Anfrage / on request / sur demande

SG	b1	a1	C1 D	C2 D	C3 D	a2	b2	e1	e2	Ød	Ød1
SG-79-C1/ SG-77-C2/ SG-7-C3	156	156	37	37	27	58	58	100	100	19	20
		196	37	37	27	98	58	140	100	19	20
		246	37	37	27	148	58	190	100	19	20
		311	37	37	27	213	58	255	100	19	20
	196	196	37	37	27	84	84	132	132	24	25
		246	37	37	27	134	84	182	132	24	25
		311	37	37	27	199	84	247	132	24	25
		396	37	37	27	284	84	332	132	24	25
		496	47	47	27	368	68	424	124	30	32
		626	47	47	27	498	68	554	124	30	32
	246	246	47	47	27	118	118	174	174	30	32
		311	47	47	27	183	118	239	174	30	32
		396	47	47	27	268	118	324	174	30	32
		496	47	47	27	368	118	424	174	30	32
		626	47 / 57	47 / 57	27	474	94	542	162	38	40
		706	47 / 57	47 / 57	27	554	94	622	162	38	40
	311	311	47	47	27	183	183	239	239	30	32
		396	47	47	27	268	183	324	239	30	32
		496	47 / 57	47 / 57	27	344	159	412	227	38	40
		626	47 / 57	47 / 57	27	474	159	542	227	38	40
		706	47 / 57	47 / 57	27	554	159	622	227	38	40
		796	47 / 57	47 / 57	27	644	159	712	227	38	40
	396	396	47 / 57	47 / 57	37	244	244	312	312	38	40
		496	47 / 57	47 / 57	37	344	244	412	312	38	40
626		57 / 67	57 / 67	37	452	222	530	300	48	50	
706		57 / 67	57 / 67	37	532	222	610	300	48	50	
796		57 / 67	57 / 67	37	622	222	700	300	48	50	
496	496	57 / 67	57 / 67	37	322	224	400	400	48	50	
	626	57 / 67	57 / 67	37	452	224	530	400	48	50	
	706	57 / 67	57 / 67	37	532	224	610	400	48	50	
	796	57 / 67	57 / 67	37	622	322	700	400	48	50	
626	626	57 / 67	57 / 67	37	452	452	530	530	48	50	
	706	57 / 67	57 / 67	37	532	452	610	530	48	50	
	796	57 / 67	57 / 67	37	622	452	700	530	48	50	

**Combi-Säulengestelle  
mit oben hängenden Säulen**

**Combi-die sets  
with aerial-mounted columns**

**Combi-blocs à colonnes  
avec colonnes montées en haut**

**Auswahl Gestellplatten**

**Selection die set plates**

**Sélection des plaques de bloc à colonnes**



siehe Seite  
see page 4.66  
voir page

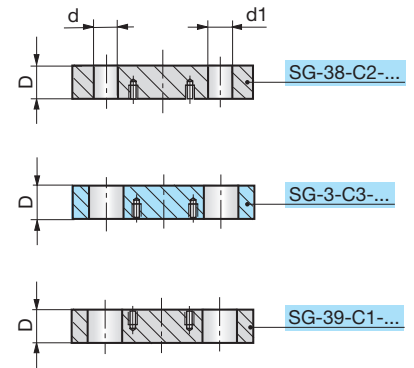
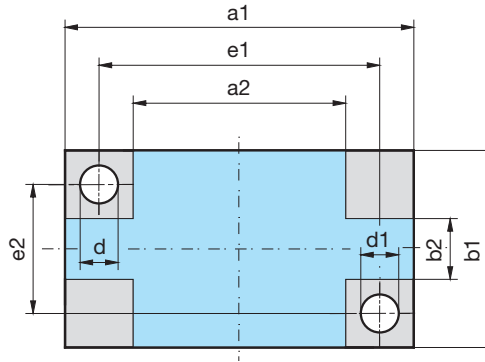

SG-39-C1-  
b1-a1-D-Mat

Mat.: 1.1730/C45W

Mat.: 3.4365 (AL)  
auf Anfrage / on request / sur demande

SG	b1	a1	C1 D	C2 D	C3 D	a2	b2	e1	e2	Ød	Ød1
SG-39-C1/ SG-38-C2/ SG-3-C3	156	156	27 / 37	27 / 37	27	48	48	100	100	19	20
		196	27 / 37	27 / 37	27	88	48	140	100	19	20
		246	27 / 37	27 / 37	27	138	48	190	100	19	20
		311	27 / 37	27 / 37	27	203	48	255	100	19	20
	196	196	27 / 37	27 / 37	27	74	74	132	132	24	25
		246	27 / 37	27 / 37	27	124	74	182	132	24	25
		311	27 / 37	27 / 37	27	189	74	247	132	24	25
		396	27 / 37	27 / 37	27	274	74	332	132	24	25
		496	37 / 47	37 / 47	27	360	60	424	124	30	32
		626	37 / 47	37 / 47	27	490	60	554	124	30	32
	246	246	37 / 47	37 / 47	27	110	110	174	174	30	32
		311	37 / 47	37 / 47	27	175	110	239	174	30	32
		396	37 / 47	37 / 47	27	260	110	324	174	30	32
		496	37 / 47	37 / 47	27	360	110	424	174	30	32
		626	47 / 57	47 / 57	27	470	90	542	162	38	40
	311	706	47 / 57	47 / 57	27	550	90	622	162	38	40
		311	37 / 47	37 / 47	27	175	175	239	239	30	32
		396	37 / 47	37 / 47	27	260	175	324	239	30	32
		496	47 / 57	47 / 57	27	340	155	412	227	38	40
		626	47 / 57	47 / 57	27	470	155	542	227	38	40
		706	47 / 57	47 / 57	27	550	155	622	227	38	40
	396	796	47 / 57	47 / 57	27	640	155	712	227	38	40
		396	47 / 57	47 / 57	37	240	240	312	312	38	40
		496	47 / 57	47 / 57	37	340	240	412	312	38	40
626		57 / 67	57 / 67	37	448	218	530	300	48	50	
706		57 / 67	57 / 67	37	528	218	610	300	48	50	
496	796	57 / 67	57 / 67	37	618	218	700	300	48	50	
	496	57 / 67	57 / 67	37	318	318	400	400	48	50	
	626	57 / 67	57 / 67	37	448	318	530	400	48	50	
	706	57 / 67	57 / 67	37	528	318	610	400	48	50	
626	796	57 / 67	57 / 67	37	618	318	700	400	48	50	
	626	57 / 67	57 / 67	37	448	448	530	530	48	50	
	706	57 / 67	57 / 67	37	528	448	610	530	48	50	
		796	57 / 67	57 / 67	37	618	448	700	530	48	50

**Combi-Säulengestelle  
mit oben hängenden Säulen**

**Combi-die sets  
with aerial-mounted columns**

**Combi-blocs à colonnes  
avec colonnes montées en haut**

**Auswahl Gestellplatten**

**Selection die set plates**

**Sélection des plaques de bloc à colonnes**

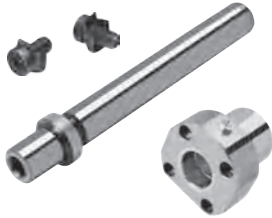

siehe Seite  
see page **4.68**  
voir page

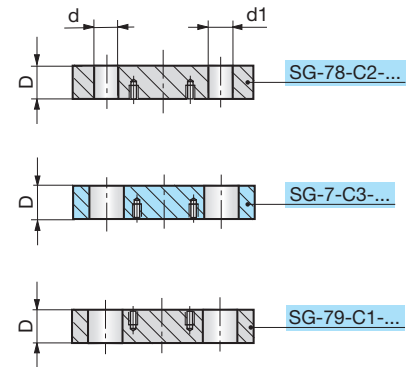
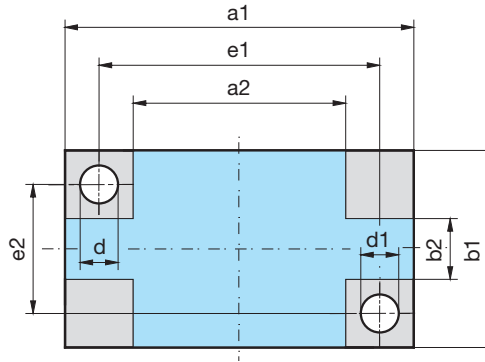

SG-79-C1-  
b1-a1-D-Mat

Mat.: 1.1730/C45W

Mat.: 3.4365 (AL)  
auf Anfrage / on request / sur demande

SG	b1	a1	C1 D	C2 D	C3 D	a2	b2	e1	e2	Ød	Ød1
SG-79-C1/ SG-78-C2/ SG-7-C3	156	156	37	27 / 37	27	58	58	100	100	19	20
		196	37	27 / 37	27	98	58	140	100	19	20
		246	37	27 / 37	27	148	58	190	100	19	20
		311	37	27 / 37	27	213	58	255	100	19	20
	196	196	37	27 / 37	27	84	84	132	132	24	25
		246	37	27 / 37	27	134	84	182	132	24	25
		311	37	27 / 37	27	199	84	247	132	24	25
		396	37	27 / 37	27	284	84	332	132	24	25
		496	47	37 / 47	27	368	68	424	124	30	32
		626	47	37 / 47	27	498	68	554	124	30	32
	246	246	47	37 / 47	27	118	118	174	174	30	32
		311	47	37 / 47	27	183	118	239	174	30	32
		396	47	37 / 47	27	268	118	324	174	30	32
		496	47	37 / 47	27	368	118	424	174	30	32
		626	47 / 57	47 / 57	27	474	94	542	162	38	40
		706	47 / 57	47 / 57	27	554	94	622	162	38	40
	311	311	47	37 / 47	27	183	183	239	239	30	32
		396	47	37 / 47	27	268	183	324	239	30	32
		496	47 / 57	47 / 57	27	344	159	412	227	38	40
		626	47 / 57	47 / 57	27	474	159	542	227	38	40
706		47 / 57	47 / 57	27	554	159	622	227	38	40	
796		47 / 57	47 / 57	27	644	159	712	227	38	40	
396	396	47 / 57	47 / 57	37	244	244	312	312	38	40	
	496	47 / 57	47 / 57	37	344	244	412	312	38	40	
	626	57 / 67	57 / 67	37	452	222	530	300	48	50	
	706	57 / 67	57 / 67	37	532	222	610	300	48	50	
	796	57 / 67	57 / 67	37	622	222	700	300	48	50	
496	496	57 / 67	57 / 67	37	322	224	400	400	48	50	
	626	57 / 67	57 / 67	37	452	224	530	400	48	50	
	706	57 / 67	57 / 67	37	532	224	610	400	48	50	
	796	57 / 67	57 / 67	37	622	322	700	400	48	50	
626	626	57 / 67	57 / 67	37	452	452	530	530	48	50	
	706	57 / 67	57 / 67	37	532	452	610	530	48	50	
	796	57 / 67	57 / 67	37	622	452	700	530	48	50	

**Combi-Säulengestelle  
mit oben hängenden Säulen**

**Combi-die sets  
with aerial-mounted columns**

**Combi-blocs à colonnes  
avec colonnes montées en haut**

**Auswahl Gestellplatten**

**Selection die set plates**

**Sélection des plaques de bloc à colonnes**



siehe Seite  
see page 4.58  
voir page

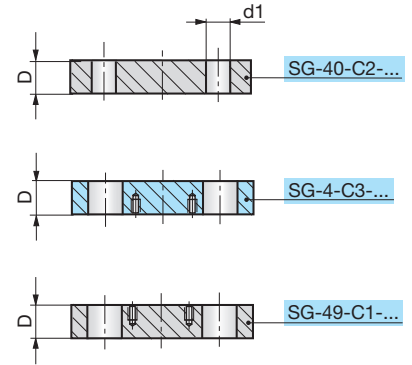
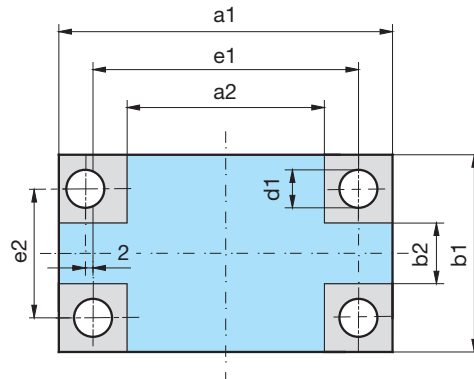

SG-49-C1-  
b1-a1-D-Mat

Mat.: 1.1730/C45W

Mat.: 3.4365 (AL)  
auf Anfrage / on request / sur demande

SG	b1	a1	C1 D	C2 D	C3 D	a2	b2	e1	e2	Ød1
SG-49-C1/ SG-40-C2/ SG-4-C3	156	156	27 / 37	27 / 37	27	48	48	100	100	20
		196	27 / 37	27 / 37	27	88	48	140	100	20
		246	27 / 37	27 / 37	27	138	48	190	100	20
		311	27 / 37	27 / 37	27	203	48	255	100	20
	196	196	27 / 37	27 / 37	27	74	74	132	132	25
		246	27 / 37	27 / 37	27	124	74	182	132	25
		311	27 / 37	27 / 37	27	189	74	247	132	25
		396	27 / 37	27 / 37	27	274	74	332	132	25
		496	37 / 47	37 / 47	27	360	60	424	124	32
		626	37 / 47	37 / 47	27	490	60	554	124	32
	246	246	37 / 47	37 / 47	27	110	110	174	174	32
		311	37 / 47	37 / 47	27	175	110	239	174	32
		396	37 / 47	37 / 47	27	260	110	324	174	32
		496	37 / 47	37 / 47	27	360	110	424	174	32
		626	47 / 57	47 / 57	27	470	90	542	162	40
		706	47 / 57	47 / 57	27	550	90	622	162	40
	311	311	37 / 47	37 / 47	27	175	175	239	239	32
		396	37 / 47	37 / 47	27	260	175	324	239	32
		496	47 / 57	47 / 57	27	340	155	412	227	40
		626	47 / 57	47 / 57	27	470	155	542	227	40
706		47 / 57	47 / 57	27	550	155	622	227	40	
796		47 / 57	47 / 57	27	640	155	712	227	40	
396	396	47 / 57	47 / 57	37	240	240	312	312	40	
	496	47 / 57	47 / 57	37	340	240	412	312	40	
	626	57 / 67	57 / 67	37	448	218	530	300	50	
	706	57 / 67	57 / 67	37	528	218	610	300	50	
	796	57 / 67	57 / 67	37	618	218	700	300	50	
496	496	57 / 67	57 / 67	37	318	318	400	400	50	
	626	57 / 67	57 / 67	37	448	318	530	400	50	
	706	57 / 67	57 / 67	37	528	318	610	400	50	
	796	57 / 67	57 / 67	37	618	318	700	400	50	
626	626	57 / 67	57 / 67	37	448	448	530	530	50	
	706	57 / 67	57 / 67	37	528	448	610	530	50	
	796	57 / 67	57 / 67	37	618	448	700	530	50	

**Combi-Säulengestelle  
mit oben hängenden Säulen**

**Combi-die sets  
with aerial-mounted columns**

**Combi-blocs à colonnes  
avec colonnes montées en haut**

**Auswahl Gestellplatten**

**Selection die set plates**

**Sélection des plaques de bloc à colonnes**



siehe Seite  
see page **4.60**  
voir page

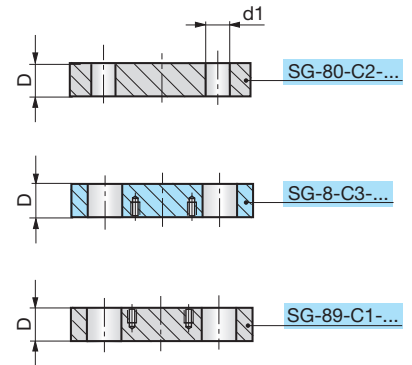
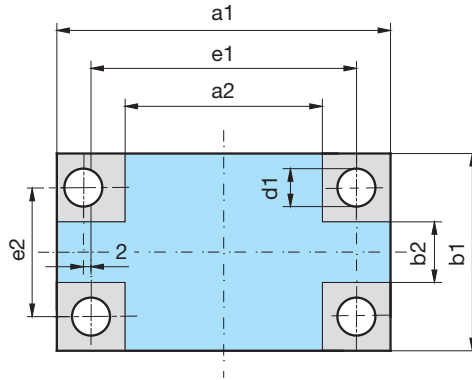

SG-89-C1-  
b1-a1-D-Mat

Mat.: 1.1730/C45W

Mat.: 3.4365 (AL)  
auf Anfrage / on request / sur demande

SG	b1	a1	C1 D	C2 D	C3 D	a2	b2	e1	e2	Ød1
SG-89-C1/ SG-80-C2/ SG-8-C3	156	156	37	27 / 37	27	58	58	100	100	20
		196	37	27 / 37	27	98	58	140	100	20
		246	37	27 / 37	27	148	58	190	100	20
		311	37	27 / 37	27	213	58	255	100	20
	196	196	37	27 / 37	27	84	84	132	132	25
		246	37	27 / 37	27	134	84	182	132	25
		311	37	27 / 37	27	199	84	247	132	25
		396	37	27 / 37	27	284	84	332	132	25
		496	47	37 / 47	27	368	68	424	124	32
		626	47	37 / 47	27	498	68	554	124	32
	246	246	47	37 / 47	27	118	118	174	174	32
		311	47	37 / 47	27	183	118	239	174	32
		396	47	37 / 47	27	268	118	324	174	32
		496	47	37 / 47	27	368	118	424	174	32
		626	47 / 57	47 / 57	27	474	94	542	162	40
		706	47 / 57	47 / 57	27	554	94	622	162	40
	311	311	47	37 / 47	27	183	183	239	239	32
		396	47	37 / 47	27	268	183	324	239	32
		496	47 / 57	47 / 57	27	344	159	412	227	40
		626	47 / 57	47 / 57	27	474	159	542	227	40
		706	47 / 57	47 / 57	27	554	159	622	227	40
		796	47 / 57	47 / 57	27	644	159	712	227	40
	396	396	47 / 57	47 / 57	37	244	244	312	312	40
		496	47 / 57	47 / 57	37	344	244	412	312	40
626		57 / 67	57 / 67	37	452	222	530	300	50	
706		57 / 67	57 / 67	37	532	222	610	300	50	
796		57 / 67	57 / 67	37	622	222	700	300	50	
496	496	57 / 67	57 / 67	37	322	322	400	400	50	
	626	57 / 67	57 / 67	37	452	322	530	400	50	
	706	57 / 67	57 / 67	37	532	322	610	400	50	
	796	57 / 67	57 / 67	37	622	322	700	400	50	
626	626	57 / 67	57 / 67	37	452	452	530	530	50	
	706	57 / 67	57 / 67	37	532	452	610	530	50	
	796	57 / 67	57 / 67	37	622	452	700	530	50	

**Combi-Säulengestelle  
mit oben hängenden Säulen**

**Combi-die sets  
with aerial-mounted columns**

**Combi-blocs à colonnes  
avec colonnes montées en haut**

**Auswahl Gestellplatten**

**Selection die set plates**

**Sélection des plaques de bloc à colonnes**



siehe Seite  
see page 4.62  
voir page

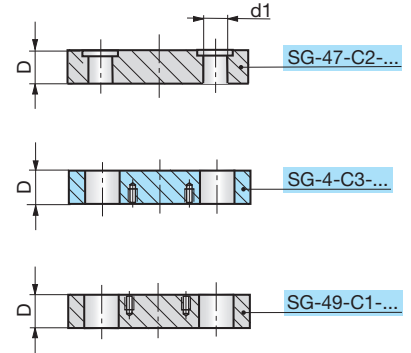
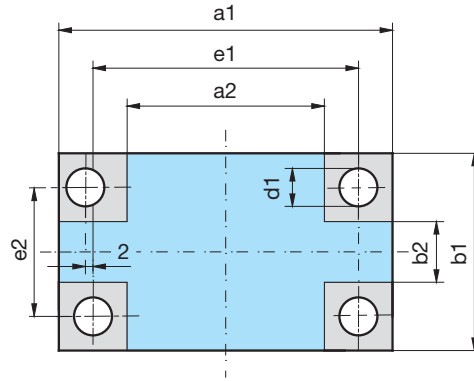

4



SG-49-C1-  
b1-a1-D-Mat

Mat.: 1.1730/C45W

Mat.: 3.4365 (AL)  
auf Anfrage / on request / sur demande

SG	b1	a1	C1 D	C2 D	C3 D	a2	b2	e1	e2	Ød1
SG-49-C1/ SG-47-C2/ SG-4-C3	156	156	27 / 37	37	27	48	48	100	100	20
		196	27 / 37	37	27	88	48	140	100	20
		246	27 / 37	37	27	138	48	190	100	20
		311	27 / 37	37	27	203	48	255	100	20
	196	196	27 / 37	37	27	74	74	132	132	25
		246	27 / 37	37	27	124	74	182	132	25
		311	27 / 37	37	27	189	74	247	132	25
		396	27 / 37	37	27	274	74	332	132	25
		496	37 / 47	47	27	360	60	424	124	32
		626	37 / 47	47	27	490	60	554	124	32
	246	246	37 / 47	47	27	110	110	174	174	32
		311	37 / 47	47	27	175	110	239	174	32
		396	37 / 47	47	27	260	110	324	174	32
		496	37 / 47	47	27	360	110	424	174	32
		626	47 / 57	47 / 57	27	470	90	542	162	40
		706	47 / 57	47 / 57	27	550	90	622	162	40
	311	311	37 / 47	47	27	175	175	239	239	32
		396	37 / 47	47	27	260	175	324	239	32
		496	47 / 57	47 / 57	27	340	155	412	227	40
		626	47 / 57	47 / 57	27	470	155	542	227	40
		706	47 / 57	47 / 57	27	550	155	622	227	40
		796	47 / 57	47 / 57	27	640	155	712	227	40
	396	396	47 / 57	47 / 57	37	240	240	312	312	40
		496	47 / 57	47 / 57	37	340	240	412	312	40
		626	57 / 67	57 / 67	37	448	218	530	300	50
		706	57 / 67	57 / 67	37	528	218	610	300	50
		796	57 / 67	57 / 67	37	618	218	700	300	50
	496	496	57 / 67	57 / 67	37	318	318	400	400	50
626		57 / 67	57 / 67	37	448	318	530	400	50	
706		57 / 67	57 / 67	37	528	318	610	400	50	
796		57 / 67	57 / 67	37	618	318	700	400	50	
626	626	57 / 67	57 / 67	37	448	448	530	530	50	
	706	57 / 67	57 / 67	37	528	448	610	530	50	
	796	57 / 67	57 / 67	37	618	448	700	530	50	



**Combi-Säulengestelle  
mit oben hängenden Säulen**

**Combi-die sets  
with aerial-mounted columns**

**Combi-blocs à colonnes  
avec colonnes montées en haut**

**Auswahl Gestellplatten**

**Selection die set plates**

**Sélection des plaques de bloc à colonnes**

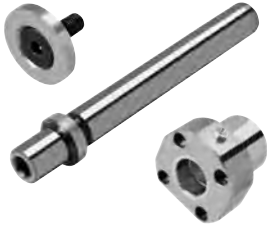

siehe Seite  
see page 4.64  
voir page

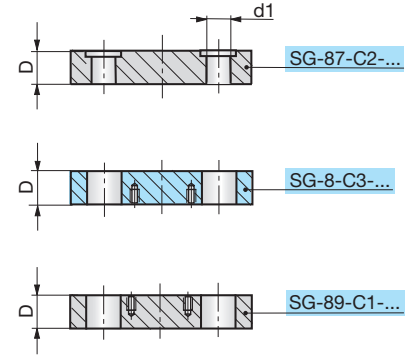
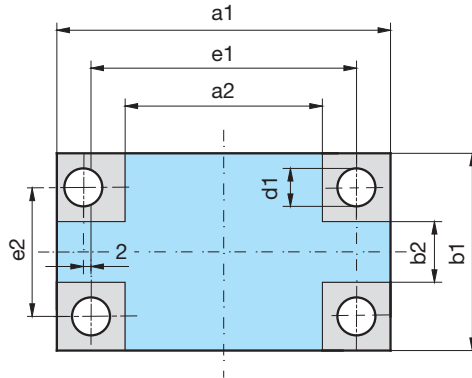

SG-89-C1-  
b1-a1-D-Mat

Mat.: 1.1730/C45W

Mat.: 3.4365 (AL)  
auf Anfrage / on request / sur demande

SG	b1	a1	C1 D	C2 D	C3 D	a2	b2	e1	e2	Ød1
SG-89-C1/ SG-87-C2/ SG-8-C3	156	156	37	37	27	58	58	100	100	20
		196	37	37	27	98	58	140	100	20
		246	37	37	27	148	58	190	100	20
		311	37	37	27	213	58	255	100	20
	196	196	37	37	27	84	84	132	132	25
		246	37	37	27	134	84	182	132	25
		311	37	37	27	199	84	247	132	25
		396	37	37	27	284	84	332	132	25
		496	47	47	27	368	68	424	124	32
		626	47	47	27	498	68	554	124	32
	246	246	47	47	27	118	118	174	174	32
		311	47	47	27	183	118	239	174	32
		396	47	47	27	268	118	324	174	32
		496	47	47	27	368	118	424	174	32
		626	47 / 57	47 / 57	27	474	94	542	162	40
		706	47 / 57	47 / 57	27	554	94	622	162	40
	311	311	47	47	27	183	183	239	239	32
		396	47	47	27	268	183	324	239	32
		496	47 / 57	47 / 57	27	344	159	412	227	40
		626	47 / 57	47 / 57	27	474	159	542	227	40
		706	47 / 57	47 / 57	27	554	159	622	227	40
		796	47 / 57	47 / 57	27	644	159	712	227	40
	396	396	47 / 57	47 / 57	37	244	244	312	312	40
		496	47 / 57	47 / 57	37	344	244	412	312	40
		626	57 / 67	57 / 67	37	452	222	530	300	50
		706	57 / 67	57 / 67	37	532	222	610	300	50
		796	57 / 67	57 / 67	37	622	222	700	300	50
	496	496	57 / 67	57 / 67	37	322	322	400	400	50
626		57 / 67	57 / 67	37	452	322	530	400	50	
706		57 / 67	57 / 67	37	532	322	610	400	50	
796		57 / 67	57 / 67	37	622	322	700	400	50	
626	626	57 / 67	57 / 67	37	452	452	530	530	50	
	706	57 / 67	57 / 67	37	532	452	610	530	50	
	796	57 / 67	57 / 67	37	622	452	700	530	50	

**Combi-Säulengestelle  
mit oben hängenden Säulen**

**Combi-die sets  
with aerial-mounted columns**

**Combi-blocs à colonnes  
avec colonnes montées en haut**

**Auswahl Gestellplatten**

**Selection die set plates**

**Sélection des plaques de bloc à colonnes**



siehe Seite  
see page 4.66  
voir page

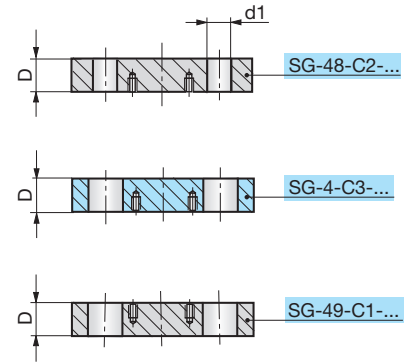
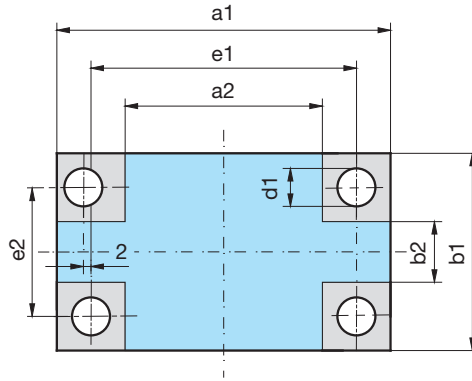

SG-49-C1-  
b1-a1-D-Mat

Mat.: 1.1730/C45W

Mat.: 3.4365 (AL)  
auf Anfrage / on request / sur demande

SG	b1	a1	C1 D	C2 D	C3 D	a2	b2	e1	e2	ød1
SG-49-C1/ SG-48-C2/ SG-4-C3	156	156	27 / 37	27 / 37	27	48	48	100	100	20
		196	27 / 37	27 / 37	27	88	48	140	100	20
		246	27 / 37	27 / 37	27	138	48	190	100	20
		311	27 / 37	27 / 37	27	203	48	255	100	20
	196	196	27 / 37	27 / 37	27	74	74	132	132	25
		246	27 / 37	27 / 37	27	124	74	182	132	25
		311	27 / 37	27 / 37	27	189	74	247	132	25
		396	27 / 37	27 / 37	27	274	74	332	132	25
		496	37 / 47	37 / 47	27	360	60	424	124	32
	246	626	37 / 47	37 / 47	27	490	60	554	124	32
		246	37 / 47	37 / 47	27	110	110	174	174	32
		311	37 / 47	37 / 47	27	175	110	239	174	32
		396	37 / 47	37 / 47	27	260	110	324	174	32
		496	37 / 47	37 / 47	27	360	110	424	174	32
		626	47 / 57	47 / 57	27	470	90	542	162	40
	311	706	47 / 57	47 / 57	27	550	90	622	162	40
		311	37 / 47	37 / 47	27	175	175	239	239	32
		396	37 / 47	37 / 47	27	260	175	324	239	32
		496	47 / 57	47 / 57	27	340	155	412	227	40
		626	47 / 57	47 / 57	27	470	155	542	227	40
706		47 / 57	47 / 57	27	550	155	622	227	40	
396	796	47 / 57	47 / 57	27	640	155	712	227	40	
	396	47 / 57	47 / 57	37	240	240	312	312	40	
	496	47 / 57	47 / 57	37	340	240	412	312	40	
	626	57 / 67	57 / 67	37	448	218	530	300	50	
	706	57 / 67	57 / 67	37	528	218	610	300	50	
496	796	57 / 67	57 / 67	37	618	218	700	300	50	
	496	57 / 67	57 / 67	37	318	318	400	400	50	
	626	57 / 67	57 / 67	37	448	318	530	400	50	
	706	57 / 67	57 / 67	37	528	318	610	400	50	
626	796	57 / 67	57 / 67	37	618	318	700	400	50	
	626	57 / 67	57 / 67	37	448	448	530	530	50	
	706	57 / 67	57 / 67	37	528	448	610	530	50	
		796	57 / 67	57 / 67	37	618	448	700	530	50

**Combi-Säulengestelle  
mit oben hängenden Säulen**

**Combi-die sets  
with aerial-mounted columns**

**Combi-blocs à colonnes  
avec colonnes montées en haut**

**Auswahl Gestellplatten**

**Selection die set plates**

**Sélection des plaques de bloc à colonnes**

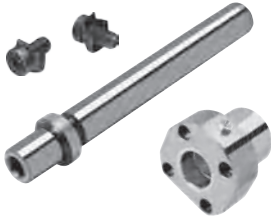

siehe Seite  
see page **4.68**  
voir page

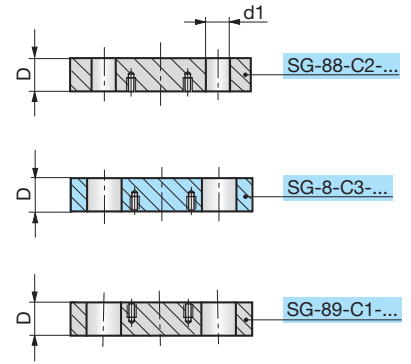
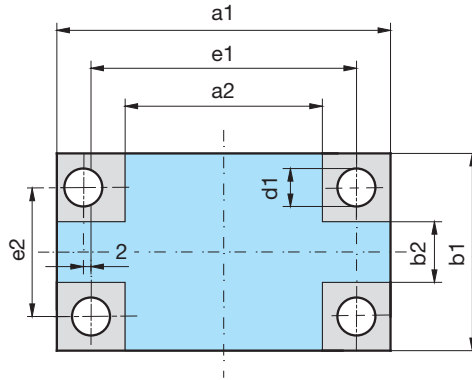

SG-89-C1-  
b1-a1-D-Mat

Mat.: 1.1730/C45W

Mat.: 3.4365 (AL)  
auf Anfrage / on request / sur demande

SG	b1	a1	C1 D	C2 D	C3 D	a2	b2	e1	e2	Ød1
SG-89-C1/ SG-88-C2/ SG-8-C3	156	156	37	27 / 37	27	58	58	100	100	20
		196	37	27 / 37	27	98	58	140	100	20
		246	37	27 / 37	27	148	58	190	100	20
		311	37	27 / 37	27	213	58	255	100	20
	196	196	37	27 / 37	27	84	84	132	132	25
		246	37	27 / 37	27	134	84	182	132	25
		311	37	27 / 37	27	199	84	247	132	25
		396	37	27 / 37	27	284	84	332	132	25
		496	47	37 / 47	27	368	68	424	124	32
		626	47	37 / 47	27	498	68	554	124	32
	246	246	47	37 / 47	27	118	118	174	174	32
		311	47	37 / 47	27	183	118	239	174	32
		396	47	37 / 47	27	268	118	324	174	32
		496	47	37 / 47	27	368	118	424	174	32
		626	47 / 57	47 / 57	27	474	94	542	162	40
		706	47 / 57	47 / 57	27	554	94	622	162	40
	311	311	47	37 / 47	27	183	183	239	239	32
		396	47	37 / 47	27	268	183	324	239	32
		496	47 / 57	47 / 57	27	344	159	412	227	40
		626	47 / 57	47 / 57	27	474	159	542	227	40
		706	47 / 57	47 / 57	27	554	159	622	227	40
		796	47 / 57	47 / 57	27	644	159	712	227	40
	396	396	47 / 57	47 / 57	37	244	244	312	312	40
		496	47 / 57	47 / 57	37	344	244	412	312	40
626		57 / 67	57 / 67	37	452	222	530	300	50	
706		57 / 67	57 / 67	37	532	222	610	300	50	
796		57 / 67	57 / 67	37	622	222	700	300	50	
496	496	57 / 67	57 / 67	37	322	322	400	400	50	
	626	57 / 67	57 / 67	37	452	322	530	400	50	
	706	57 / 67	57 / 67	37	532	322	610	400	50	
	796	57 / 67	57 / 67	37	622	322	700	400	50	
626	626	57 / 67	57 / 67	37	452	452	530	530	50	
	706	57 / 67	57 / 67	37	532	452	610	530	50	
	796	57 / 67	57 / 67	37	622	452	700	530	50	

**Combi-Säulengestelle  
mit oben hängenden Säulen**

**Combi-die sets  
with aerial-mounted columns**

**Combi-blocs à colonnes  
avec colonnes montées en haut**

**Auswahl Gestellplatten**

**Selection die set plates**

**Sélection des plaques de bloc à colonnes**



siehe Seite  
see page 4.58  
voir page

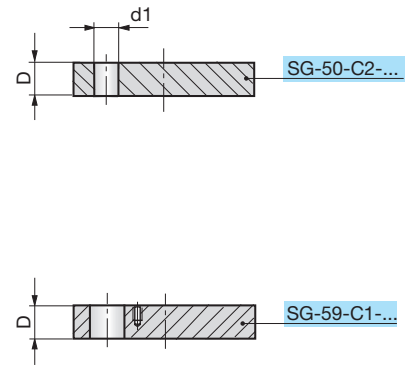
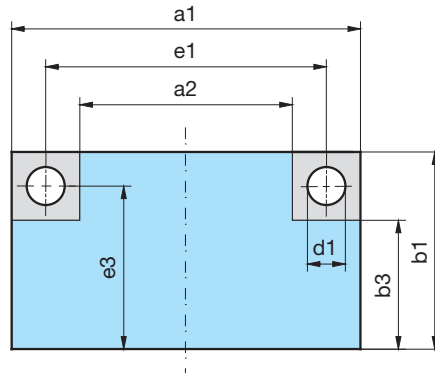

SG-59-C1-  
b1-a1-D-Mat

Mat.: 1.1730/C45W

Mat.: 3.4365 (AL)  
auf Anfrage / on request / sur demande

SG	b1	a1	C1 D	C2 D	a2	b3	e1	e3	Ød1
SG-59-C1/ SG-50-C2	156	156	27 / 37	27 / 37	48	102	100	128	20
		196	27 / 37	27 / 37	88	102	140	128	20
		246	27 / 37	27 / 37	138	102	190	128	20
		311	27 / 37	27 / 37	203	102	255	128	20
	196	196	27 / 37	27 / 37	74	135	132	164	25
		246	27 / 37	27 / 37	124	135	182	164	25
		311	27 / 37	27 / 37	189	135	247	164	25
		396	27 / 37	27 / 37	274	135	332	164	25
		496	37 / 47	37 / 47	360	128	424	160	32
		626	37 / 47	37 / 47	490	128	554	160	32
	246	246	37 / 47	37 / 47	110	178	174	210	32
		311	37 / 47	37 / 47	175	178	239	210	32
		396	37 / 47	37 / 47	260	178	324	210	32
		496	37 / 47	37 / 47	360	178	424	210	32
		626	47 / 57	47 / 57	470	168	542	204	40
		706	47 / 57	47 / 57	550	168	622	204	40
	311	311	37 / 47	37 / 47	175	243	239	275	32
		396	37 / 47	37 / 47	260	243	324	275	32
		496	47 / 57	47 / 57	340	233	412	269	40
		626	47 / 57	47 / 57	470	233	542	269	40
		706	47 / 57	47 / 57	550	233	622	269	40
		796	47 / 57	47 / 57	640	233	712	269	40
	396	396	47 / 57	47 / 57	240	318	312	354	40
		496	47 / 57	47 / 57	340	318	412	354	40
		626	57 / 67	57 / 67	448	307	530	348	50
		706	57 / 67	57 / 67	528	307	610	348	50
		796	57 / 67	57 / 67	618	307	700	348	50
	496	496	57 / 67	57 / 67	318	407	400	448	50
626		57 / 67	57 / 67	448	407	530	448	50	
706		57 / 67	57 / 67	528	407	610	448	50	
796		57 / 67	57 / 67	618	407	700	448	50	
626	626	57 / 67	57 / 67	448	537	530	578	50	
	706	57 / 67	57 / 67	528	537	610	578	50	
	796	57 / 67	57 / 67	618	537	700	578	50	

**Combi-Säulengestelle  
mit oben hängenden Säulen**

**Combi-die sets  
with aerial-mounted columns**

**Combi-blocs à colonnes  
avec colonnes montées en haut**

**Auswahl Gestellplatten**

**Selection die set plates**

**Sélection des plaques de bloc à colonnes**



siehe Seite  
see page **4.60**  
voir page

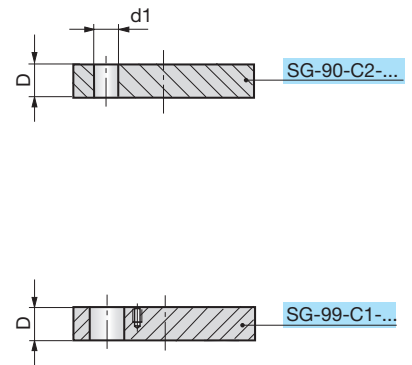
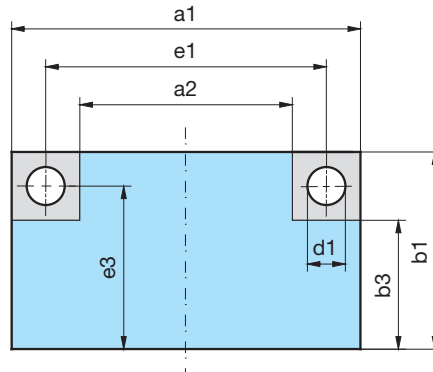

SG-99-C1-  
b1-a1-D-Mat

Mat.: 1.1730/C45W

Mat.: 3.4365 (AL)  
auf Anfrage / on request / sur demande

SG	b1	a1	C1 D	C2 D	a2	b3	e1	e3	Ød1
SG-99-C1/ SG-90-C2	156	156	37	27 / 37	58	107	100	128	20
		196	37	27 / 37	98	107	140	128	20
		246	37	27 / 37	148	107	190	128	20
		311	37	27 / 37	213	107	255	128	20
	196	196	37	27 / 37	84	140	132	164	25
		246	37	27 / 37	134	140	182	164	25
		311	37	27 / 37	199	140	247	164	25
		396	37	27 / 37	284	140	332	164	25
		496	47	37 / 47	368	132	424	160	32
		626	47	37 / 47	498	132	554	160	32
	246	246	47	37 / 47	118	182	174	210	32
		311	47	37 / 47	183	182	239	210	32
		396	47	37 / 47	268	182	324	210	32
		496	47	37 / 47	368	182	424	210	32
		626	47 / 57	47 / 57	474	170	542	204	40
		706	47 / 57	47 / 57	554	170	622	204	40
	311	311	47	37 / 47	183	247	239	275	32
		396	47	37 / 47	268	247	324	275	32
		496	47 / 57	47 / 57	344	235	412	269	40
		626	47 / 57	47 / 57	474	235	542	269	40
		706	47 / 57	47 / 57	554	235	622	269	40
		796	47 / 57	47 / 57	644	235	712	269	40
	396	396	47 / 57	47 / 57	244	320	312	354	40
		496	47 / 57	47 / 57	344	320	412	354	40
		626	57 / 67	57 / 67	452	309	530	348	50
		706	57 / 67	57 / 67	532	309	610	348	50
		796	57 / 67	57 / 67	622	309	700	348	50
	496	496	57 / 67	57 / 67	322	409	400	448	50
626		57 / 67	57 / 67	452	409	530	448	50	
706		57 / 67	57 / 67	532	409	610	448	50	
796		57 / 67	57 / 67	622	409	700	448	50	
626	626	57 / 67	57 / 67	452	539	530	578	50	
	706	57 / 67	57 / 67	532	539	610	578	50	
	796	57 / 67	57 / 67	622	539	700	578	50	

**Combi-Säulengestelle  
mit oben hängenden Säulen**

**Combi-die sets  
with aerial-mounted columns**

**Combi-blocs à colonnes  
avec colonnes montées en haut**

**Auswahl Gestellplatten**

**Selection die set plates**

**Sélection des plaques de bloc à colonnes**



siehe Seite  
see page 4.62  
voir page

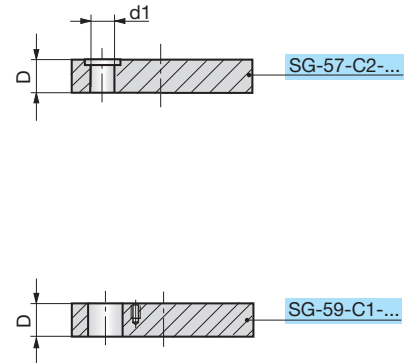
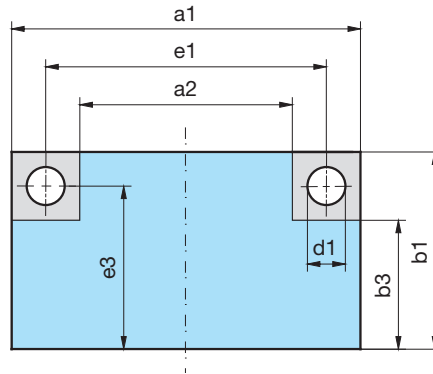

SG-59-C1-  
b1-a1-D-Mat

Mat.: 1.1730/C45W

Mat.: 3.4365 (AL)  
auf Anfrage / on request / sur demande

SG	b1	a1	C1 D	C2 D	a2	b3	e1	e3	Ød1
SG-59-C1/ SG-57-C2	156	156	27 / 37	37	48	102	100	128	20
		196	27 / 37	37	88	102	140	128	20
		246	27 / 37	37	138	102	190	128	20
		311	27 / 37	37	203	102	255	128	20
	196	196	27 / 37	37	74	135	132	164	25
		246	27 / 37	37	124	135	182	164	25
		311	27 / 37	37	189	135	247	164	25
		396	27 / 37	37	274	135	332	164	25
		496	37 / 47	47	360	128	424	160	32
		626	37 / 47	47	490	128	554	160	32
	246	246	37 / 47	47	110	178	174	210	32
		311	37 / 47	47	175	178	239	210	32
		396	37 / 47	47	260	178	324	210	32
		496	37 / 47	47	360	178	424	210	32
		626	47 / 57	47 / 57	470	168	542	204	40
		706	47 / 57	47 / 57	550	168	622	204	40
	311	311	37 / 47	47	175	243	239	275	32
		396	37 / 47	47	260	243	324	275	32
		496	47 / 57	47 / 57	340	233	412	269	40
		626	47 / 57	47 / 57	470	233	542	269	40
		706	47 / 57	47 / 57	550	233	622	269	40
		796	47 / 57	47 / 57	640	233	712	269	40
	396	396	47 / 57	47 / 57	240	318	312	354	40
		496	47 / 57	47 / 57	340	318	412	354	40
		626	57 / 67	57 / 67	448	307	530	348	50
		706	57 / 67	57 / 67	528	307	610	348	50
		796	57 / 67	57 / 67	618	307	700	348	50
	496	496	57 / 67	57 / 67	318	407	400	448	50
626		57 / 67	57 / 67	448	407	530	448	50	
706		57 / 67	57 / 67	528	407	610	448	50	
796		57 / 67	57 / 67	618	407	700	448	50	
626	626	57 / 67	57 / 67	448	537	530	578	50	
	706	57 / 67	57 / 67	528	537	610	578	50	
	796	57 / 67	57 / 67	618	537	700	578	50	

**Combi-Säulengestelle  
mit oben hängenden Säulen**

**Combi-die sets  
with aerial-mounted columns**

**Combi-blocs à colonnes  
avec colonnes montées en haut**

**Auswahl Gestellplatten**

**Selection die set plates**

**Sélection des plaques de bloc à colonnes**



siehe Seite  
see page 4.64  
voir page

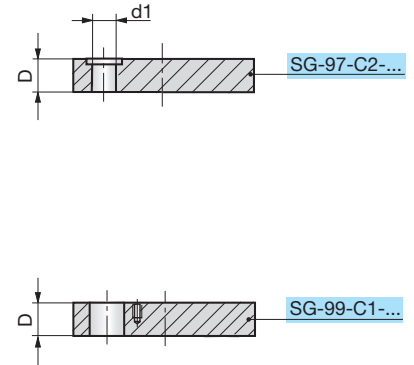
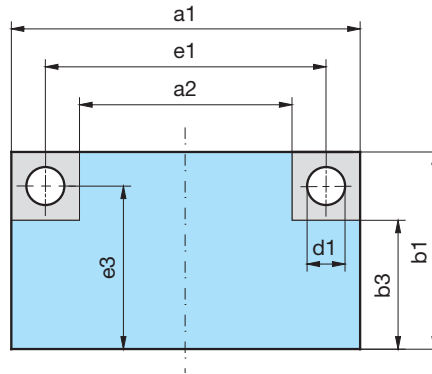

SG-99-C1-  
b1-a1-D-Mat

Mat.: 1.1730/C45W

Mat.: 3.4365 (AL)  
auf Anfrage / on request / sur demande

SG	b1	a1	C1 D	C2 D	a2	b3	e1	e3	Ød1
SG-99-C1/ SG-97-C2	156	156	37	37	58	107	100	128	20
		196	37	37	98	107	140	128	20
		246	37	37	148	107	190	128	20
		311	37	37	213	107	255	128	20
	196	196	37	37	84	140	132	164	25
		246	37	37	134	140	182	164	25
		311	37	37	199	140	247	164	25
		396	37	37	284	140	332	164	25
		496	47	47	368	132	424	160	32
		626	47	47	498	132	554	160	32
	246	246	47	47	118	182	174	210	32
		311	47	47	183	182	239	210	32
		396	47	47	268	182	324	210	32
		496	47	47	368	182	424	210	32
		626	47 / 57	47 / 57	474	170	542	204	40
		706	47 / 57	47 / 57	554	170	622	204	40
	311	311	47	47	183	247	239	275	32
		396	47	47	268	247	324	275	32
		496	47 / 57	47 / 57	344	235	412	269	40
		626	47 / 57	47 / 57	474	235	542	269	40
		706	47 / 57	47 / 57	554	235	622	269	40
		796	47 / 57	47 / 57	644	235	712	269	40
	396	396	47 / 57	47 / 57	244	320	312	354	40
		496	47 / 57	47 / 57	344	320	412	354	40
		626	57 / 67	57 / 67	452	309	530	348	50
		706	57 / 67	57 / 67	532	309	610	348	50
		796	57 / 67	57 / 67	622	309	700	348	50
	496	496	57 / 67	57 / 67	322	409	400	448	50
626		57 / 67	57 / 67	452	409	530	448	50	
706		57 / 67	57 / 67	532	409	610	448	50	
796		57 / 67	57 / 67	622	409	700	448	50	
626	626	57 / 67	57 / 67	452	539	530	578	50	
	706	57 / 67	57 / 67	532	539	610	578	50	
	796	57 / 67	57 / 67	622	539	700	578	50	

**Combi-Säulengestelle  
mit oben hängenden Säulen**

**Combi-die sets  
with aerial-mounted columns**

**Combi-blocs à colonnes  
avec colonnes montées en haut**

**Auswahl Gestellplatten**

**Selection die set plates**

**Sélection des plaques de bloc à colonnes**



siehe Seite  
see page 4.66  
voir page

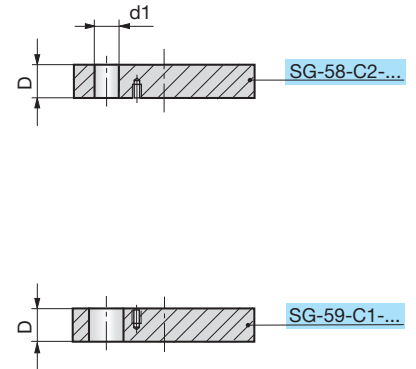
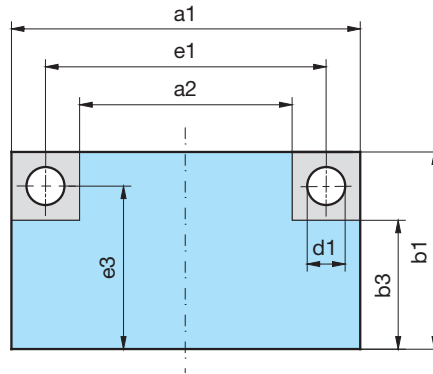

SG-59-C1-  
b1-a1-D-Mat

Mat.: 1.1730/C45W

Mat.: 3.4365 (AL)  
auf Anfrage / on request / sur demande

SG	b1	a1	C1 D	C2 D	a2	b3	e1	e3	Ød1
SG-59-C1/ SG-58-C2	156	156	27 / 37	27 / 37	48	102	100	128	20
		196	27 / 37	27 / 37	88	102	140	128	20
		246	27 / 37	27 / 37	138	102	190	128	20
		311	27 / 37	27 / 37	203	102	255	128	20
	196	196	27 / 37	27 / 37	74	135	132	164	25
		246	27 / 37	27 / 37	124	135	182	164	25
		311	27 / 37	27 / 37	189	135	247	164	25
		396	27 / 37	27 / 37	274	135	332	164	25
		496	37 / 47	37 / 47	360	128	424	160	32
		626	37 / 47	37 / 47	490	128	554	160	32
	246	246	37 / 47	37 / 47	110	178	174	210	32
		311	37 / 47	37 / 47	175	178	239	210	32
		396	37 / 47	37 / 47	260	178	324	210	32
		496	37 / 47	37 / 47	360	178	424	210	32
		626	47 / 57	47 / 57	470	168	542	204	40
		706	47 / 57	47 / 57	550	168	622	204	40
	311	311	37 / 47	37 / 47	175	243	239	275	32
		396	37 / 47	37 / 47	260	243	324	275	32
		496	47 / 57	47 / 57	340	233	412	269	40
		626	47 / 57	47 / 57	470	233	542	269	40
		706	47 / 57	47 / 57	550	233	622	269	40
		796	47 / 57	47 / 57	640	233	712	269	40
	396	396	47 / 57	47 / 57	240	318	312	354	40
		496	47 / 57	47 / 57	340	318	412	354	40
		626	57 / 67	57 / 67	448	307	530	348	50
		706	57 / 67	57 / 67	528	307	610	348	50
		796	57 / 67	57 / 67	618	307	700	348	50
	496	496	57 / 67	57 / 67	318	407	400	448	50
626		57 / 67	57 / 67	448	407	530	448	50	
706		57 / 67	57 / 67	528	407	610	448	50	
796		57 / 67	57 / 67	618	407	700	448	50	
626	626	57 / 67	57 / 67	448	537	530	578	50	
	706	57 / 67	57 / 67	528	537	610	578	50	
	796	57 / 67	57 / 67	618	537	700	578	50	



**Combi-Säulengestelle  
mit oben hängenden Säulen**

**Combi-die sets  
with aerial-mounted columns**

**Combi-blocs à colonnes  
avec colonnes montées en haut**

**Auswahl Gestellplatten**

**Selection die set plates**

**Sélection des plaques de bloc à colonnes**

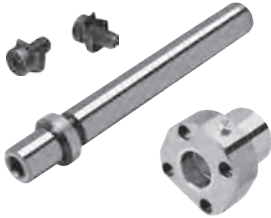

siehe Seite  
see page **4.68**  
voir page

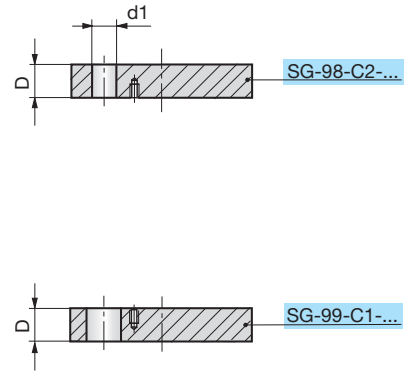
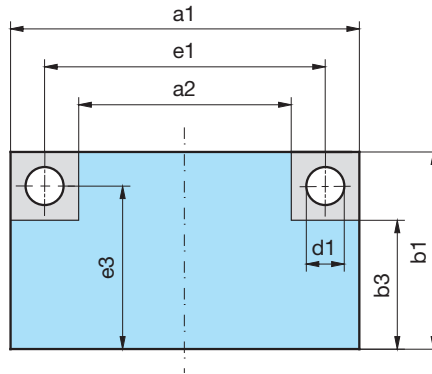

SG-99-C1-  
b1-a1-D-Mat

Mat.: 1.1730/C45W

Mat.: 3.4365 (AL)  
auf Anfrage / on request / sur demande

SG	b1	a1	C1 D	C2 D	a2	b3	e1	e3	Ød1
SG-99-C1/ SG-98-C2	156	156	37	27 / 37	58	107	100	128	20
		196	37	27 / 37	98	107	140	128	20
		246	37	27 / 37	148	107	190	128	20
		311	37	27 / 37	213	107	255	128	20
	196	196	37	27 / 37	84	140	132	164	25
		246	37	27 / 37	134	140	182	164	25
		311	37	27 / 37	199	140	247	164	25
		396	37	27 / 37	284	140	332	164	25
		496	47	37 / 47	368	132	424	160	32
		626	47	37 / 47	498	132	554	160	32
	246	246	47	37 / 47	118	182	174	210	32
		311	47	37 / 47	183	182	239	210	32
		396	47	37 / 47	268	182	324	210	32
		496	47	37 / 47	368	182	424	210	32
		626	47 / 57	47 / 57	474	170	542	204	40
		706	47 / 57	47 / 57	554	170	622	204	40
	311	311	47	37 / 47	183	247	239	275	32
		396	47	37 / 47	268	247	324	275	32
		496	47 / 57	47 / 57	344	235	412	269	40
		626	47 / 57	47 / 57	474	235	542	269	40
		706	47 / 57	47 / 57	554	235	622	269	40
		796	47 / 57	47 / 57	644	235	712	269	40
	396	396	47 / 57	47 / 57	244	320	312	354	40
		496	47 / 57	47 / 57	344	320	412	354	40
		626	57 / 67	57 / 67	452	309	530	348	50
		706	57 / 67	57 / 67	532	309	610	348	50
		796	57 / 67	57 / 67	622	309	700	348	50
	496	496	57 / 67	57 / 67	322	409	400	448	50
626		57 / 67	57 / 67	452	409	530	448	50	
706		57 / 67	57 / 67	532	409	610	448	50	
796		57 / 67	57 / 67	622	409	700	448	50	
626	626	57 / 67	57 / 67	452	539	530	578	50	
	706	57 / 67	57 / 67	532	539	610	578	50	
	796	57 / 67	57 / 67	622	539	700	578	50	

**Führungssäulen  
eingepresst**

**Guide pillars  
pressed-in**

**Colonnes de guidage  
sertie**

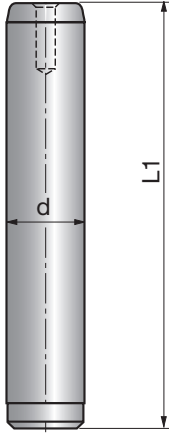

4

**Z 4310-**

Mat.: 1.0503/63±2HRC  
~ DIN 9825-2/ISO 9182

 Z 4310-d-L



d	L	d	L1	d	L1	d	L1	d	L1
19/20	100	24/25	100	30/32	120	38/40	140	48/50	170
	110		130		150		180		
	120		140		160		190		
	130		125		150		200		
	140		130		160		210		
	150		140		170		220		
	160		150		180		240		
	170		160		190		250		
	180		170		200		260		
	190		180		210		280		
	200		190		220		300		
	220		200		240		320		
	240		210		250		340		
	250		220		260		360		
	260		230		280		380		
	280		240		300		400		
	300		250		320		450		
	360		260		340		500		
	400		280		360				
			300		380				
	320	400							
	360	450							
	400	500							
	450								

**Führungsbuchsen  
mit Bund**

**Guide bushes  
with collar**

**Bagues de guidage  
avec épaulement**

SN 4190-

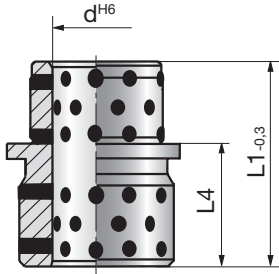

Z 4411-

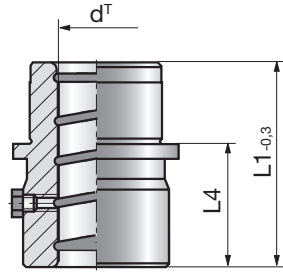

Z 4412-

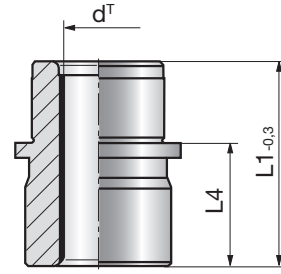

Z 4415-

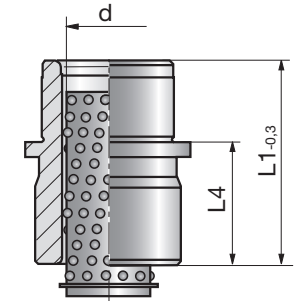

**SN 4190-**

Mat.: Bronze 190 -220 HB  
190 S10/3000 DIN 9834/  
ISO 9448 < 150 °C

**Z 4411-**

Mat.: 1.1740  
HRC 52 ±2+CuSn12  
~ DIN 9831-1/ISO 9448

 SN 4190-d-L1



 Z 4411-d-L1-T



**Z 4412-**

Mat.-Nr. 1.0501  
Sint-B50+MoS2  
~ DIN 9831-1/ISO 9448

**Z 4415-**

Mat.: 1.3505/  
63±2HRC+CuZn40  
~ DIN 9831-2/ISO 9448

 Z 4412-d-L1-T



 Z 4415-d-L1



a) siehe Seite Info 4.75  
see page Info 4.77  
voir page Info 4.79  
**T = B**  $\triangle$  Standard

d	L1	L4	d	L1	L4	d	L1	L4	d	L1	L4	d	L1	L4	T <sup>a)</sup>
19/20	32	12	24/25	35	12	30/32	42	12	38/40	50	15	48/50	65	20	A/B/C
	50	30		60	37		75	45		80	45		90	45	A/B/C
	70	50		80	57		95	65		110	75		120	75	A/B/C

Type 1      Type 2

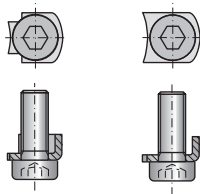

**Z 4325-**

Mat.: 1.0330

Type	d
1	16 - 32
2	38 - 80

 Z 4325-Type



**Führungssäulen  
eingepresst**

**Guide pillars  
pressed-in**

**Colonnes de guidage  
sertie**

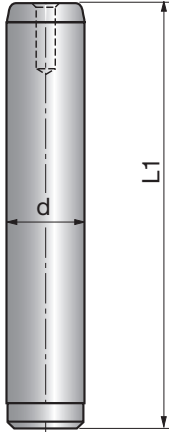

4

**Z 4310-**

Mat.: 1.0503/63±2HRC  
~ DIN 9825-2/ISO 9182

 Z 4310-d-L



d	L	d	L1	d	L1	d	L1	d	L1
19/20	100	24/25	100	30/32	120	38/40	140	48/50	170
	110		110		130		150		180
	120		120		140		160		190
	130		125		150		170		200
	140		130		160		180		210
	150		140		170		190		220
	160		150		180		200		240
	170		160		190		210		250
	180		170		200		220		260
	190		180		210		230		280
	200		190		220		240		300
	220		200		240		250		320
	240		210		250		260		340
	250		220		260		270		360
	260		230		280		280		380
	280		240		300		300		400
	300		250		320		320		450
	360		260		340		340		500
	400		280		360		360		
			300		380		380		
			320		400		400		
			360		450		450		
			400		500		500		
			450						

**Führungsbuchsen mit Flansch**

**Guide bushes with flange**

**Bagues de guidage avec collerette**

SN 1766-

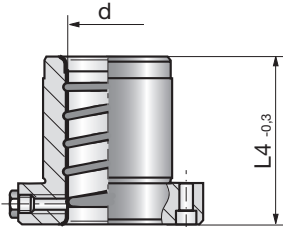

SN 1769-

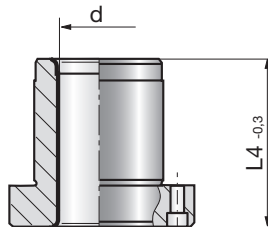

**SN 1766-**

Mat.: 1.1740  
52 ±2HRC+CuSn12

**SN 1769-**

Mat.: 1.0501  
Sint-B50+MoS2

a) siehe Seite Info 4.75  
see page Info 4.77  
voir page Info 4.79  
T = B  $\hat{=}$  Standard

 SN 1766-d-L4-T



 SN 1769-d-L4-T



4

d	L4	d	L4	d	L4	d	L4	d	L4	T <sup>a)</sup>
19/20	35	24/25	40	30/32	50	38/40	60	48/50	80	A/B/C
	50		60		75		85		100	A/B/C

SN 1778-

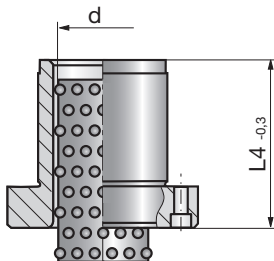

**SN 1778-**

Mat.: 1.3505  
63 ±2HRC+CuZn40

 SN 1778-d-L4



d	L4	d	L4	d	L4	d	L4	d	L4
19/20	38	24/25	40	30/32	47	38/40	56	48/50	66
	51		60		70		80		90

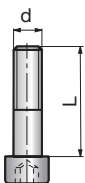

**SN 3500-**

DIN EN ISO 4762-10.9

 SN 3500-d-L



d	L	Ø	SN 1766 SN 1769		SN 1778 L4	d	L	Ø	SN 1766 SN 1769		SN 1778 L4
			L4	L4					L4	L4	
M4	12	19/20	35	38	M6	25	38/40	60	56	M8	35
	25		50	51				85	80		
M5	16	24/25	40	40	45	48/50	80	66			
	25		60	60			100	90			
	16		30/32	50			47				
	30		75	70							

**Führungssäulen mit Bund und Haltescheiben**

**Guide pillars with collar and retaining plates**

**Colonnes de guidage avec épaulement et rondelles de fixation**

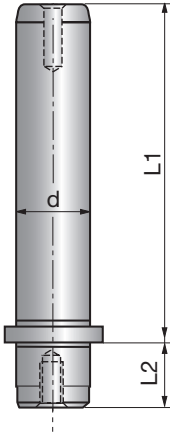

light line

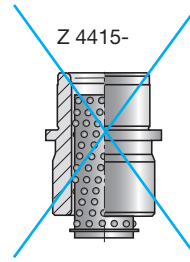
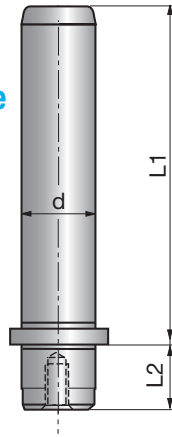

4

**SN 4321-**

Mat.: 1.0503/63±2HRC  
~ DIN 9825-2/ISO 9182

**SN 4322-**

Mat.: 1.0503/63±2HRC  
~ DIN 9825-2/ISO 9182

 SN 4321-d-L1



 SN 4322-d-L1



d	L1	L2
19/20	100	23
	112	23
	125	23
	140	23
	160	23
	180	23
	200	23

d	L1	L2
24/25	100	30
	112	30
	125	30
	140	30
	160	30
	180	30
	200	30
	224	30
250	30	

d	L1	L2
30/32	112	37
	125	37
	140	37
	160	37
	180	37
	200	37
	224	37
	250	37
	280	37
	315	37

d	L1	L2
38/40	125	37
	140	37
	160	37
	180	37
	200	37
	224	37
	250	37
	280	37

d	L1	L2
48/50	140	47
	160	47
	180	47
	200	47
	224	47
	250	47
	280	47
	315	47
355	47	
400	47	

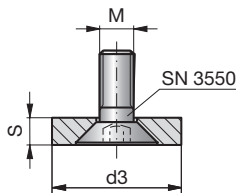

**SN 1707-**

Mat.: 1.0718

 SN 1707-d3-M



d3	M	d	S
25	M8	19/20	5,5
32	M8	24/25	5,5
40	M8	30/32	7,5
50	M8	38/40	9,5

**Führungsbuchsen  
mit Bund**

**Guide bushes  
with collar**

**Bagues de guidage  
avec épaulement**

SN 4190-

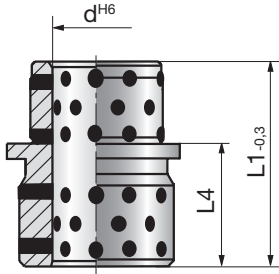

Z 4411-

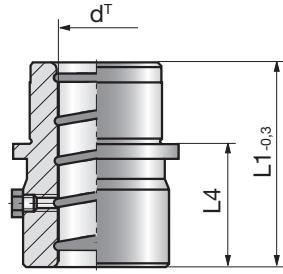

Z 4412-

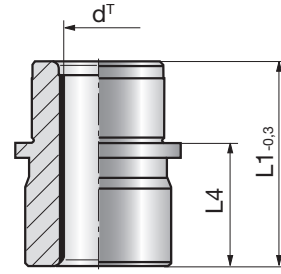

Z 4415-

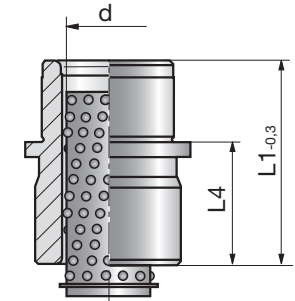

**SN 4190-**

Mat.: Bronze 190 -220 HB  
190 S10/3000 DIN 9834/  
ISO 9448 < 150 °C

**Z 4411-**

Mat.: 1.1740  
HRC 52 ±2+CuSn12  
~ DIN 9831-1/ISO 9448

 SN 4190-d-L1



 Z 4411-d-L1-T



**Z 4412-**

Mat.-Nr. 1.0501  
Sint-B50+MoS2  
~ DIN 9831-1/ISO 9448

**Z 4415-**

Mat.: 1.3505/  
63±2HRC+CuZn40  
~ DIN 9831-2/ISO 9448

 Z 4412-d-L1-T



 Z 4415-d-L1



a) siehe Seite Info 4.75  
see page Info 4.77  
voir page Info 4.79  
T = B Δ Standard

d	L1	L4	d	L1	L4	d	L1	L4	d	L1	L4	d	L1	L4	T <sup>a)</sup>
19/20	32	12	24/25	35	12	30/32	42	12	38/40	50	15	48/50	65	20	A/B/C
	50	30		60	37		75	45		80	45		90	45	A/B/C
	70	50		80	57		95	65		110	75		120	75	A/B/C

Type 1      Type 2

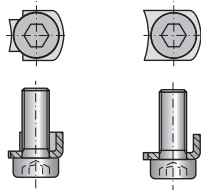

**Z 4325-**

Mat.: 1.0330

Type	d
1	16 - 32
2	38 - 80

 Z 4325-Type



**Führungssäulen mit Bund und Haltescheiben**

**Guide pillars with collar and retaining plates**

**Colonnes de guidage avec épaulement et rondelles de fixation**

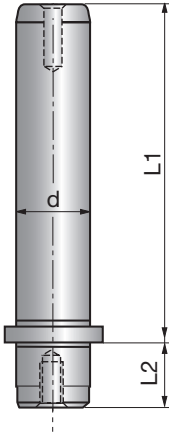

light line

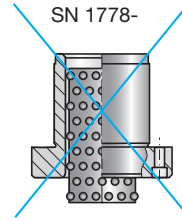
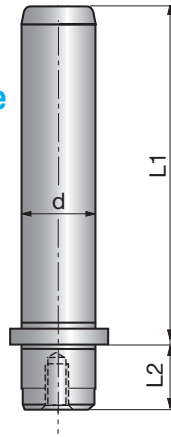

4

**SN 4321-**

Mat.: 1.0503/63±2HRC  
~ DIN 9825-2/ISO 9182

**SN 4322-**

Mat.: 1.0503/63±2HRC  
~ DIN 9825-2/ISO 9182

 SN 4321-d-L1



 SN 4322-d-L1



d	L1	L2
19/20	100	23
	112	23
	125	23
	140	23
	160	23
	180	23
	200	23

d	L1	L2
24/25	100	30
	112	30
	125	30
	140	30
	160	30
	180	30
	200	30
	224	30
250	30	

d	L1	L2
30/32	112	37
	125	37
	140	37
	160	37
	180	37
	200	37
	224	37
	250	37
	280	37
	315	37

d	L1	L2
38/40	125	37
	140	37
	160	37
	180	37
	200	37
	224	37
	250	37
	280	37
315	37	
355	37	

d	L1	L2
48/50	140	47
	160	47
	180	47
	200	47
	224	47
	250	47
	280	47
	315	47
355	47	
400	47	

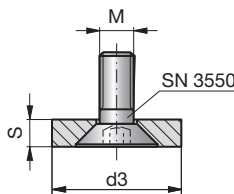

**SN 1707-**

Mat.: 1.0718

 SN 1707-d3-M



d3	M	d	S
25	M8	19/20	5,5
32	M8	24/25	5,5
40	M8	30/32	7,5
50	M8	38/40	9,5



**Führungsbuchsen  
mit Flansch**

**Guide bushes  
with flange**

**Bagues de guidage  
avec collerette**

SN 1766-

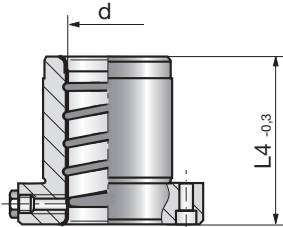

SN 1769-

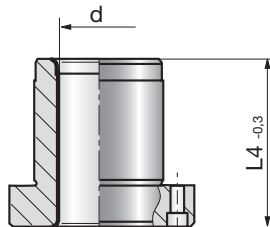

**SN 1766-**

Mat.: 1.1740  
52 ±2HRC+CuSn12

**SN 1769-**

Mat.: 1.0501  
Sint-B50+MoS2

a) siehe Seite Info 4.75  
see page Info 4.77  
voir page Info 4.79  
T = B  $\hat{=}$  Standard

 SN 1766-d-L4-T



 SN 1769-d-L4-T



d	L4	d	L4	d	L4	d	L4	d	L4	T <sup>a)</sup>
19/20	35	24/25	40	30/32	50	38/40	60	48/50	80	A/B/C
	50		60		75		85		100	A/B/C

SN 1778-

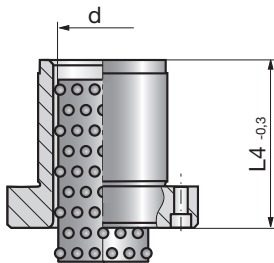

**SN 1778-**

Mat.: 1.3505  
63 ±2HRC+CuZn40

 SN 1778-d-L4



d	L4	d	L4	d	L4	d	L4	d	L4
19/20	38	24/25	40	30/32	47	38/40	56	48/50	66
	51		60		70		80		90

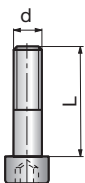

**SN 3500-**

DIN EN ISO 4762-10.9

 SN 3500-d-L



d	L	Ø	SN 1766 SN 1769		SN 1778 L4	d	L	Ø	SN 1766 SN 1769		SN 1778 L4
			L4	L4					L4	L4	
M4	12	19/20	35	38	M6	25	38/40	60	56		
	25		50	51		85		80			
M5	16	24/25	40	40	M8	35	48/50	80	66		
	25		60	60		100		90			
	16		50	47							
	30		75	70							

**Führungssäulen mit Bund und Halteklammern**

**Guide pillars with collar and fixing devices**

**Colonnes de guidage avec épaulement et brides de fixation**

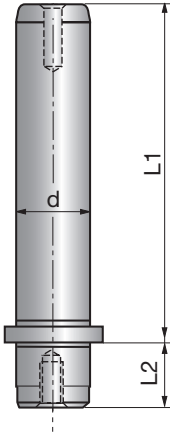

light line

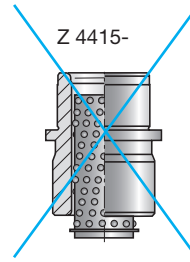
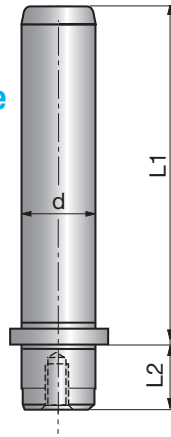

4

**SN 4321-**

Mat.: 1.0503/63±2HRC  
~ DIN 9825-2/ISO 9182

**SN 4322-**

Mat.: 1.0503/63±2HRC  
~ DIN 9825-2/ISO 9182

 SN 4321-d-L1



 SN 4322-d-L1



d	L1	L2
19/20	100	23
	112	23
	125	23
	140	23
	160	23
	180	23
	200	23

d	L1	L2
24/25	100	30
	112	30
	125	30
	140	30
	160	30
	180	30
	200	30
	224	30
250	30	

d	L1	L2
30/32	112	37
	125	37
	140	37
	160	37
	180	37
	200	37
	224	37
	250	37
	280	37
	315	37

d	L1	L2
38/40	125	37
	140	37
	160	37
	180	37
	200	37
	224	37
	250	37
	280	37

d	L1	L2
48/50	140	47
	160	47
	180	47
	200	47
	224	47
	250	47
	280	47
	315	47
355	47	
400	47	

Type 1

Type 2



**Z 4325-**

Mat.: 1.0330

Type	d
1	16 - 32
2	38 - 80

 Z 4325-Type



**Führungsbuchsen mit Bund**

**Guide bushes with collar**

**Bagues de guidage avec épaulement**

SN 4190-

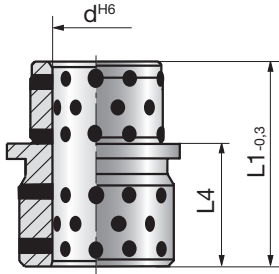

Z 4411-

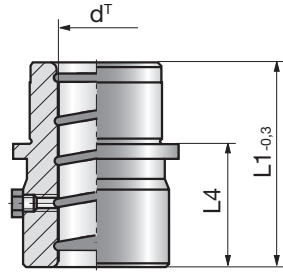

Z 4412-

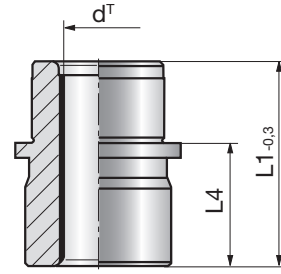

Z 4415-

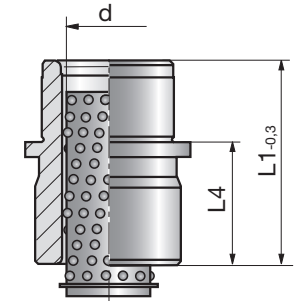

**SN 4190-**

Mat.: Bronze 190 -220 HB  
190 S10/3000 DIN 9834/  
ISO 9448 < 150 °C

**Z 4411-**

Mat.: 1.1740  
HRC 52 ±2+CuSn12  
~ DIN 9831-1/ISO 9448

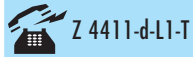

**Z 4412-**

Mat.-Nr. 1.0501  
Sint-B50+MoS2  
~ DIN 9831-1/ISO 9448

**Z 4415-**

Mat.: 1.3505/  
63±2HRC+CuZn40  
~ DIN 9831-2/ISO 9448

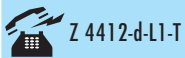

a) siehe Seite Info 4.75  
see page Info 4.77  
voir page Info 4.79  
T = B  $\triangle$  Standard

d	L1	L4	d	L1	L4	d	L1	L4	d	L1	L4	d	L1	L4	T <sup>a)</sup>
19/20	32	12	24/25	35	12	30/32	42	12	38/40	50	15	48/50	65	20	A/B/C
	50	30		60	37		75	45		80	45		90	45	A/B/C
	70	50		80	57		95	65		110	75		120	75	A/B/C

Type 1      Type 2

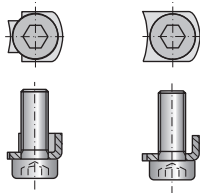

**Z 4325-**

Mat.: 1.0330

Type	d
1	16 - 32
2	38 - 80



**Führungssäulen mit Bund und Halteklammern**

**Guide pillars with collar and fixing devices**

**Colonnes de guidage avec épaulement et brides de fixation**

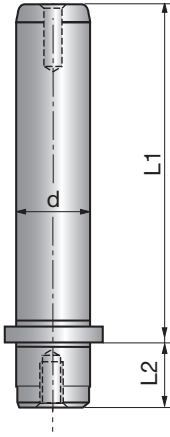

light line

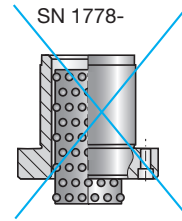
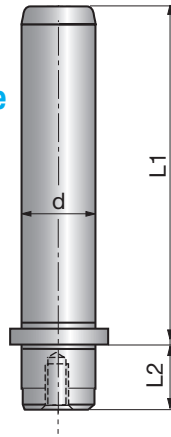

4

**SN 4321-**

Mat.: 1.0503/63±2HRC  
~ DIN 9825-2/ISO 9182

**SN 4322-**

Mat.: 1.0503/63±2HRC  
~ DIN 9825-2/ISO 9182

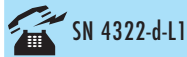

d	L1	L2
19/20	100	23
	112	23
	125	23
	140	23
	160	23
	180	23
	200	23

d	L1	L2
24/25	100	30
	112	30
	125	30
	140	30
	160	30
	180	30
	200	30
	224	30
250	30	

d	L1	L2
30/32	112	37
	125	37
	140	37
	160	37
	180	37
	200	37
	224	37
	250	37
	280	37
	315	37

d	L1	L2
38/40	125	37
	140	37
	160	37
	180	37
	200	37
	224	37
	250	37
	280	37

d	L1	L2
48/50	140	47
	160	47
	180	47
	200	47
	224	47
	250	47
	280	47
	315	47
355	47	
400	47	

Type 1      Type 2

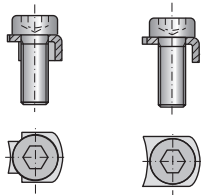

**Z 4325-**

Mat.: 1.0330

Type	d
1	16 - 32
2	38 - 80

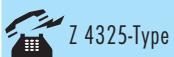

**Führungsbuchsen mit Flansch**

**Guide bushes with flange**

**Bagues de guidage avec collerette**

SN 1766-

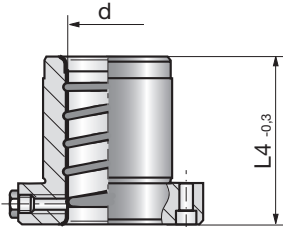

SN 1769-

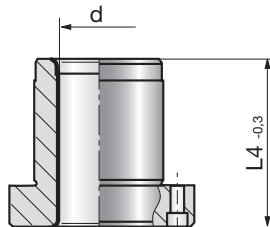

**SN 1766-**

Mat.: 1.1740  
52 ±2HRC+CuSn12

**SN 1769-**

Mat.: 1.0501  
Sint-B50+MoS2

a) siehe Seite Info 4.75  
see page Info 4.77  
voir page Info 4.79  
T = B ⚙ Standard

 SN 1766-d-L4-T



 SN 1769-d-L4-T



4

d	L4	d	L4	d	L4	d	L4	d	L4	T <sup>a)</sup>
19/20	35	24/25	40	30/32	50	38/40	60	48/50	80	A/B/C
	50		60		75		85		100	A/B/C

SN 1778-

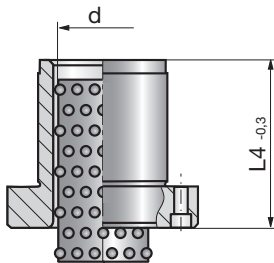

**SN 1778-**

Mat.: 1.3505  
63 ±2HRC+CuZn40

 SN 1778-d-L4



d	L4	d	L4	d	L4	d	L4	d	L4
19/20	38	24/25	40	30/32	47	38/40	56	48/50	66
	51		60		70		80		90

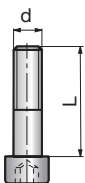

**SN 3500-**

DIN EN ISO 4762-10.9

 SN 3500-d-L



d	L	Ø	SN 1766 SN 1769		SN 1778 L4	d	L	Ø	SN 1766 SN 1769		SN 1778 L4
			L4	L4					L4	L4	
M4	12	19/20	35	38	M6	25	38/40	60	56		
	25		50	51		85		80			
M5	16	24/25	40	40	M8	35	48/50	80	66		
	25		60	60		100		90			
	16		30/32	50		47					
30	75	70									

**Anfrage / Inquiry / Demande de devis**      **1 / 2**  
 **Auftrag / Order / Bon de commande**

**STRACK NORMA GmbH & Co. KG**

Königsberger Str. 11  
 58511 Lüdenscheid  
 Tel.: 0 23 51 / 87 01-0  
 Fax: 0 23 51 / 87 01-100  
 E-Mail: info@strack.de

Firma / Company / Société

Straße / Street / Rue

Ort / Town / Ville

Name / Nom

Tel., Fax

Auftrags-Nr. / Order No. / V/Réf.

Dat.

*Fotokopieren, ausfüllen und per Fax an uns.  
 Please copy, fill in and fax to us.  
 Photocopier, remplir et nous retourner.*

Mat.: 1.1730

Mat.: 3.4365 (AL)

4

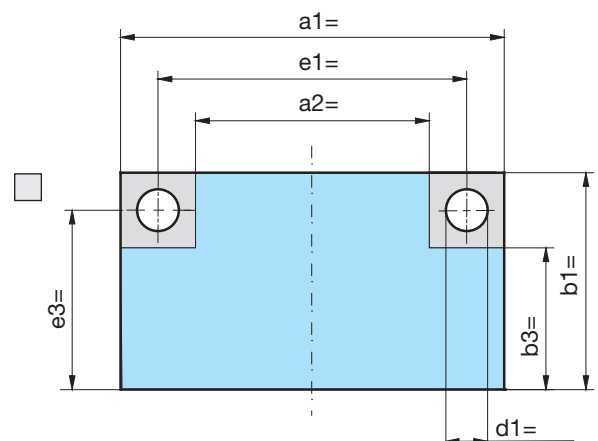
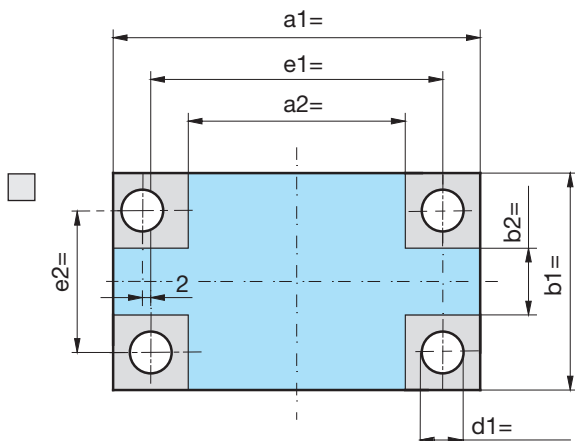
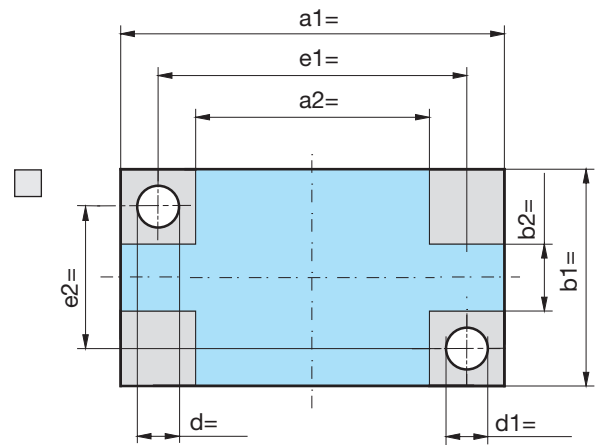
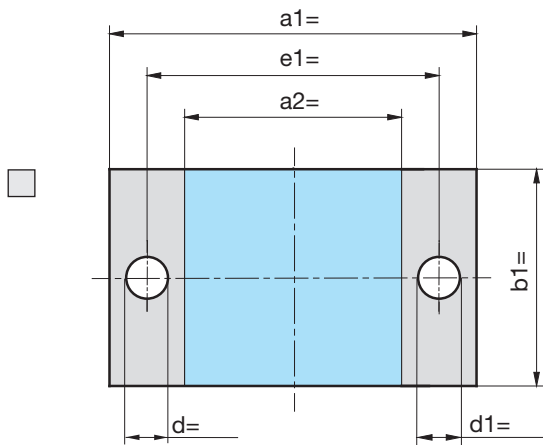
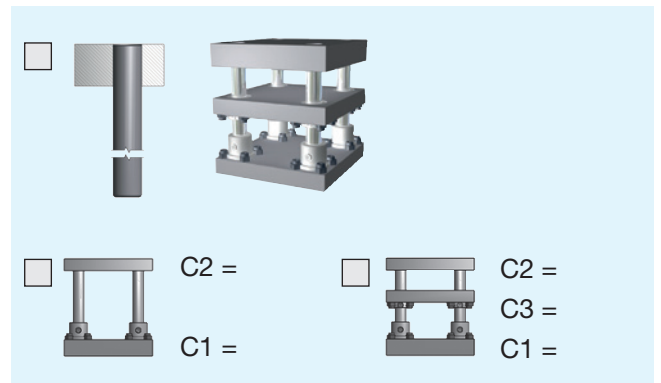
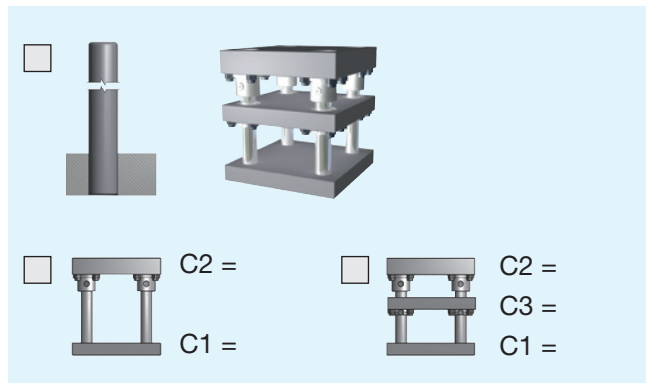

**Anfrage / Inquiry / Demande de devis**      **2 / 2**  
 **Auftrag / Order / Bon de commande**

Fotokopieren, ausfüllen und per Fax an uns.  
 Please copy, fill in and fax to us.  
 Photocopier, remplir et nous retourner.

Firma / Company / Société

Auftrags-Nr. / Order No. / V/Réf. \_\_\_\_\_ Dat. \_\_\_\_\_

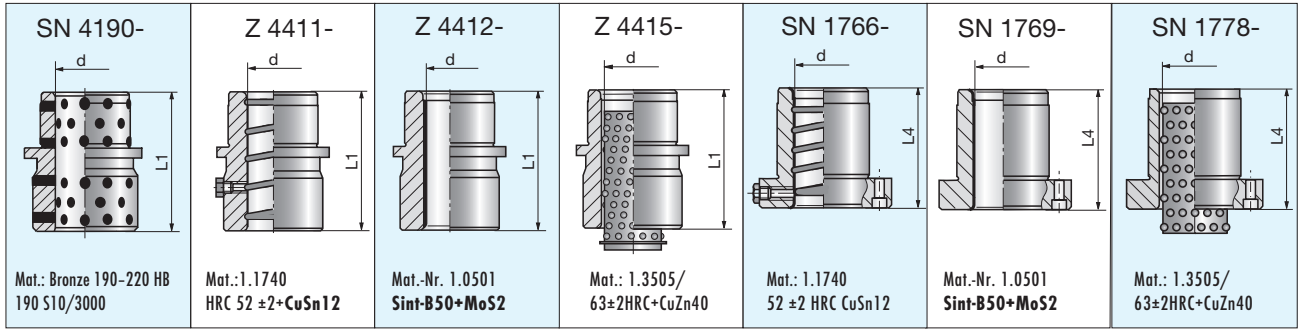

d	L1	$\frac{1}{2}$ .....8	L1	$\frac{1}{2}$ .....8	L1	$\frac{1}{2}$ .....8	L1	$\frac{1}{2}$ .....8	L4	$\frac{1}{2}$ .....8	L4	$\frac{1}{2}$ .....8	L4	$\frac{1}{2}$ .....8
19														
20														
24														
25														
30														
32														
38														
40														
48														
50														

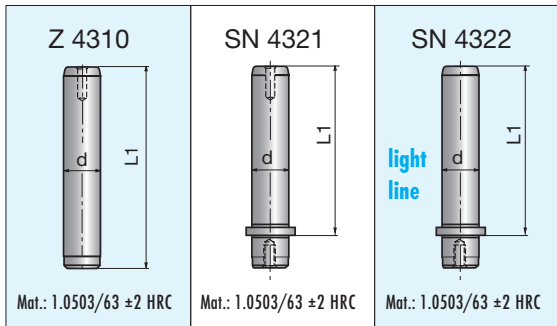

d	L1	$\frac{1}{2}$ .....8	L1	$\frac{1}{2}$ .....8	L1	$\frac{1}{2}$ .....8
19						
20						
24						
25						
30						
32						
38						
40						
48						
50						

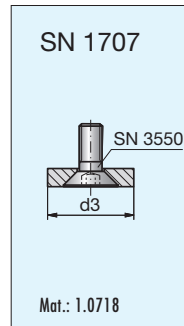

d3	$\frac{1}{2}$ .....8
25	
32	
40	
50	

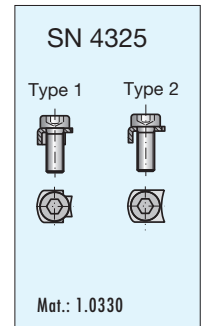

Type	$\frac{1}{2}$ .....8
1	
∅ 16 - 32	
2	
∅ 38 - 80	

SN 4190 / Z 4411 / Z 4412 / Z 4415	
d	S
19/20	26
24/25	29
30/32	32
38/40	36
48/50	41

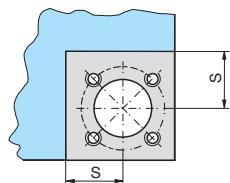

SN 1766 / SN 1769 / SN 1778		
d	S	S1
19/20	20	-
24/25	24	30
30/32	27	34
38/40	33	40
48/50	38	46

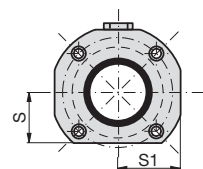

4

4

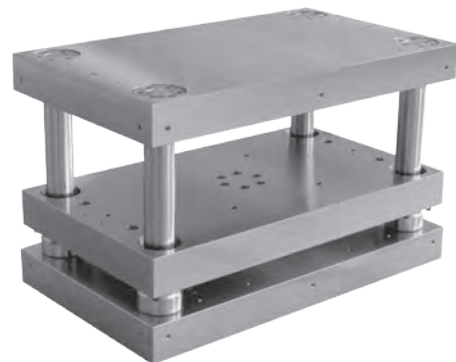
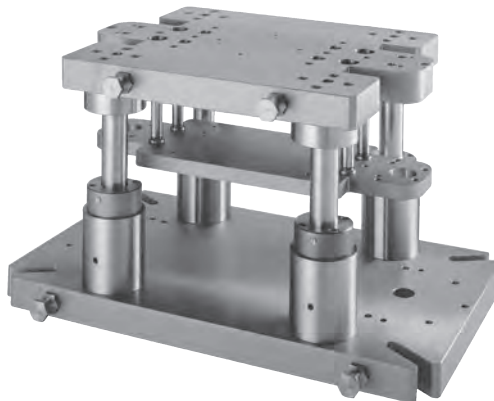
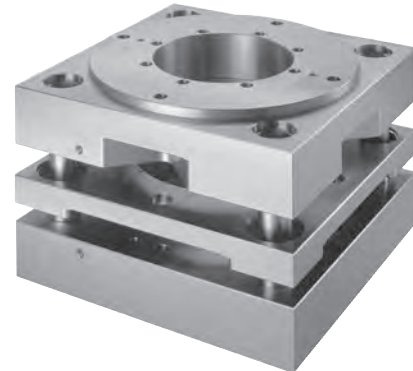
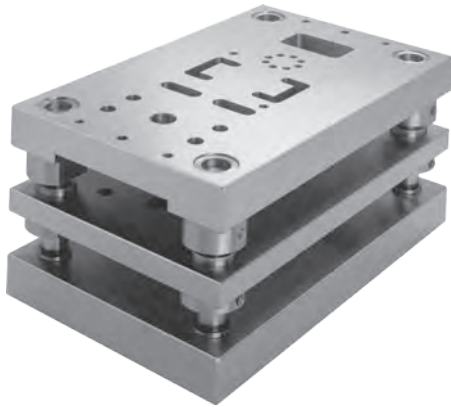

mehr Informationen siehe  
Kapitel 1.7: Sondergestelle und Zusatzbearbeitungen

more informations see  
Chapter 1.7: Special Die Sets and Additional Machining Facilities

pour information, voir  
Chapitre 1.7: Blocs spéciaux et usinages complémentaires







**INFORMATIONEN KAPITEL 4**  
**INFORMATION CHAPTER 4**  
**INFORMATIONS CHAPITRE 4**

## Information deutsch

Alle Gleitführungsbuchsen sind mit einem Toleranzkennzeichen A/B/C versehen, so dass eine optimale Auswahl des erforderlichen Gesamtlaufspiels konstruktiv vorbestimmt werden kann.

Auswahlkriterien des Führungsspiels:

- nach dem Schneidspalt
- nach der Werkstoffdicke
- nach Art und Erhaltungszustand der Arbeitsmaschine.

(Siehe Tabelle Paarungsklassifizierung Seite 4.73.)

### Z 4310

Führungssäulen ~ DIN 9825 zum Einpressen

Werkstoff 1.1213

Oberflächenhärte  $63 \pm 2$  HRC

induktiv gehärtet

Die Lauffläche der Säule ist feingeschliffen und gefiniert.

Der 7 mm lange Zentrieransatz ermöglicht ein problemloses Einsetzen der Säule in die Aufnahmebohrung und garantiert, dass beim Einpressen ein Verkanten vermieden wird.

Ab dem Durchmesser 19 mm sind alle Säulen mit einem Innengewinde M 8 x 20 zur Befestigung eines Käfighalters Z 4327 versehen.

Einbau in die Aufnahmebohrung siehe Seite 4.78 (Toleranzblatt).

Bei der Montage wird durch das Auftragen von Z 9060 eine Kaltverschweißung vermieden.

Anwendungsgebiet:

Bei allen Arten von Säulengestellen sowie im Maschinen-, Vorrichtungs- und Apparatebau.

### Z 4321

Führungssäulen DIN 9825-4 mit Bund

Werkstoff 1.1213

Oberflächenhärte  $63 \pm 2$  HRC

induktiv gehärtet

Sie sind leicht und schnell zu demontieren und erleichtern dadurch das Nachschleifen der Werkzeuge.

Zur Befestigung sind wahlweise Haltescheiben SN 1707 oder Halteklammern Z 4325 einzusetzen.

Einbau in Aufnahmebohrung siehe Seite 4.78 (Toleranzblatt).

Ab dem Durchmesser 19 mm sind alle Säulen mit einem Innengewinde M 8 x 20 zur Befestigung eines Käfighalters Z 4327 versehen.

Bei der Montage wird durch das Auftragen von Z 9060 eine Kaltverschweißung vermieden.

Anwendungsgebiet:

Bei allen Arten von Stanzwerkzeugen, bei denen eine schnelle Montage oder Demontage der Säulen erforderlich ist.

### Z 4322 light line

Führungssäulen DIN 9825-4 mit Bund wie Ausführung SN 4321 jedoch kopfseitig kein Gewinde. Laufflächen Durchmesserstoleranz h4 ohne finishing (Rz = 4).

Nur für Einsatz mit Gleitführungsbuchsen geeignet!

### Z 4411 / SN 1766

Bronzebeschichtete Führungsbuchsen

Z 4411 ~ DIN 9831/ISO 9448.

Die harte Sonderbronze (Zugfestigkeit 855 N/mm<sup>2</sup>) besitzt eine sehr gute Wärmeleitfähigkeit, sodass entstehende Reibungswärme sehr schnell abgeführt werden kann. Ein Kaltverschweißen, auch bei starker Reibung zwischen Säule und Buchse, wird somit weitgehend vermieden. Die Bronzebeschichtung (Schichtdicke ca. 0,1 mm), wird galvanisch auf einen gehärteten Stahlkörper aufgetragen, der verhindert, dass sich die Buchse bei starker Kantenpressung deformiert. Sie ist somit für hohe Gleitgeschwindigkeit (15–30 m/min.), lange Lebensdauer, größte Führungsgenauigkeit bei sichergestellter Ölversorgung geeignet.

Alle bronzebeschichteten Buchsen sind mit einem Schmiernippel, Anschlussgewinde M 8 x 1/kurze Ausführung M 6, versehen.

Bei schnelllaufenden Stanzautomaten wird nach Entfernen des Schmiernippels der Anschluss an die Zentralschmierung der Maschinen empfohlen.

Einbau in die Aufnahmebohrung Passung H5.

Vor der Montage wird das Auftragen von Festschmierstoff Z 9060 auf den Einbaudurchmesser empfohlen. Alle Buchsen der Serie Z 44. . und SN 4190 sind pro Führungsdurchmesserpaar mit einem einheitlichen Außendurchmesser versehen und somit untereinander austauschbar.

### Z 4412 / SN 1769

Feststoffgeschmierte, wartungsfreie Führungsbuchsen aus Sinterbronze

Z 4412 ~ DIN 9831/ISO 9448.

In dieser Sinterbronze ist in gleicher und feiner Verteilung Molybdänsulfid als Festschmierstoff eingelagert. Die guten Gleiteigenschaften einer gesinterten Bronze mit der hervorragenden Schmierwirkung von MoS<sub>2</sub> sind somit vereint.

Die Sinterbronze ist von einem Stahlmantel umgeben, der maßlich DIN 9831/ISO 9448 (Z 4412) entspricht. Diese Buchse eignet sich überall dort, wo

- flüssige Schmierstoffe nicht vertretbare Rückstände hinterlassen würden (Lebensmittelverarbeitung/Verpackung, Textil- und Papiermaschinenbau).

Einbau in die Aufnahmebohrung Passung H5.

Vor der Montage wird das Auftragen von Festschmierstoff Z 9060 auf den Einbaudurchmesser empfohlen.

Das Herausfahren der Führungssäule aus der Buchse bei jedem Arbeitshub ist zu vermeiden.

Max. Gleitgeschwindigkeit zwischen 30 – 60 m/min.

### SN 4190

Feststoffgeschmierte, wartungsarme Gleitführungsbuchsen aus Bronze

Sie eignen sich besonders für den Einsatz bei hohen Belastungen, bei Gleitgeschwindigkeiten < 0,5 m/s, sowie schwer zugänglichen Lagerstellen.

Die Anordnung der Festschmierstoff-Einsätze erfolgte so, dass in Gleitrichtung eine Überdeckung gegeben ist. Die Festschmierstoff-Einsätze gewährleisten einen gleichmäßigen Schmierfilm zwischen Säule und Buchse, der einen metallischen Kontakt verhindert und einem Anfressen entgegenwirkt. Die Gleitführungsbuchsen sind für lineare und drehende Gleitrichtungen ausgelegt.

Temperatur-Einsatzbereich - 50 + 150° C

(Eigenerwärmung beachten)

Härteunterschied zwischen

Buchse und Säule > 150 HB.

Zu beachten ist das größere Laufspiel, besonders bei drehender Bewegung.

Diese Buchsen sind mit folgenden Säulen kombinierbar: SN 1705, SN 4321, Z 4310, Z 4315, Z 4318, Z 4320, Z 4330.

### Z 4415 / SN 1778

Wälzführungsbuchsen

Z 4415 ~ DIN 9831/ISO 9448 mit Kugelförmigen aus Messing SN 1799 werden höchsten Anforderungen an Leichtgängigkeit, Lebensdauer und Wartungsfreiheit gerecht und werden vorwiegend bei schnelllaufenden kurzhubigen Pressen ab 400 Hüben/min. eingesetzt.

Die Lastaufnahme senkrecht zur Bewegungsrichtung ist abhängig vom Kugeldurchmesser, von der Anzahl der im Eingriff befindlichen (tragenden) Kugeln und von der Vorspannung (negatives Führungsspiel). Da die Erhöhung der Vorspannung zu Lasten der Lebensdauer und der Leichtgängigkeit geht, können auftretende Seitenkräfte nur über die Führungslänge aufgenommen und beeinflusst werden. Somit sollte in der unteren Hublage, wo die max. Belastung zu erwarten ist, der Kugelförmig über seine gesamte Länge im Eingriff (tragend) sein. Vor der Montage wird das Auftragen von Festschmierstoff Z 9060 auf den Einbaudurchmesser empfohlen.

### Z 4425

Wie Z 4415, jedoch zusätzlich mit 2 Anlauffringen als Hubbegrenzung für den Kugelförmig SN 1798.

Bevorzugter Einsatz im 2-Platten-Werkzeug.

### SN 1798

Kugelförmig aus Messing.

Die einzelnen Kugeln sind ringförmig versetzt angeordnet, so dass jede Kugel auf einer eigenen Bahn läuft. Die Kugeln sind aus hochverschleißfestem, gehärtetem Spezialstahl hergestellt und entsprechen der Güteklasse 1, Sortierung 0, DIN 5401.

Alle Kugelförmige SN 1798 und SN 1799 sind mit erhöhter Kugelzahl ausgestattet und somit unempfindlicher gegen Seitenkräfte.

### SN 1799

Wie SN 1798, jedoch mit zusätzlichem Seegering versehen, der ein „Wandern“ des Käfigs verhindert.

## Information deutsch

### Paarungsklassifizierung - Führungssäulen mit Gleitführungen

#### Schneidspalte:

Die Feststellung der Schneidspalte durch den Konstrukteur hängt in hohem Maße von der Ausführung des Blechwerkstückes ab: Anteil Glattzone/ Bruchzone, sowie erlaubte Grathöhe. Weitere Einflussfaktoren sind: Stoff-Eigenschaften des Werkstückes sowie Art und Zustand der verwendeten Arbeitsmaschine.

#### Auswahlkriterien des Führungsspiels:

Nach dem Schneidspalt; nach der Werkstoffdicke; nach Art und Erhaltungszustand der Arbeitsmaschine.

Schneidspalte		
klein	Werkstücke mit engen Toleranzen und bestimmten Eigenschaften der geschnittenen Konturen, außerdem dünne Werkstoffe.	Klasse 1
mittel	Werkstücke aus Blechen dicker als 1 mm, vorzugsweise bei Folge-Verbund-Werkzeugen.	Klasse 2
groß	Bei geringen Anforderungen an die Kantenausbildung; Schneidedruck und Schneidarbeit sind bei großen Schneidspalten eindeutig geringer als bei kleinen oder mittleren Schneidspalten.	Klasse 3

Führungsspiel	Führungssäule	Führungsbuchse
Klasse 1	A	A
Klasse 2	A	B
Klasse 3	A	C

Klasse 2 = Standard

4

Führungssäule $\mu\text{m}$		Gesamt- führungs- spiel $\mu\text{m}$	Führungsbuchse $\mu\text{m}$																												
A																															
$\varnothing$ 15/16	A	4 - 9																													$\varnothing$ 15/16
		7 - 14																													
		12 - 19																													
$\varnothing$ 19/20	A	4 - 11																													$\varnothing$ 19/20
		9 - 16																													
		14 - 22																													
$\varnothing$ 24/25	A	5 - 12																													$\varnothing$ 24/25
		10 - 18																													
		16 - 25																													
$\varnothing$ 30/32	A	5 - 12																													$\varnothing$ 30/32
		10 - 19																													
		17 - 28																													
$\varnothing$ 38/40	A	5 - 13																													$\varnothing$ 38/40
		11 - 21																													
		19 - 32																													
$\varnothing$ 48/50	A	6 - 14																													$\varnothing$ 48/50
		12 - 23																													
		21 - 35																													
$\varnothing$ 60/63	A	6 - 14																													$\varnothing$ 60/63
		12 - 24																													
		22 - 36																													
$\varnothing$ 80	A	7 - 13																													$\varnothing$ 80
		13 - 23																													
		23 - 36																													

Bei Bestellungen ohne nähere Angaben wird wie folgt geliefert:

		Führungssäule	Führungsbuchse
Führungssäulen	SN 1705 - Z 4330	A	
Führungsbuchsen / Führungslager	SN 1769 - Z 4411	A	B
Stahlgestelle, Zweisäulenausführung		A	B
Stahlgestelle, Viersäulenausführung		A	B - C

## Information english

All guide bushes are marked A/B/C for tolerance so that the required total play can be optimally selected from the outset.

Criteria for selecting the play:

- die clearance
- material thickness
- type and condition of the machine used

(see table "Classification of pairs" on page 4.75).

### Z 4310

Guide pillars ~ DIN 9825 for pressing in  
Material 1.1213

Surface hardness  $63 \pm 2$  HRC

Induction-hardened

The running surface of the pillar is precision ground and super finished.

The 7 mm long centering shoulder ensures that the pillar can be fitted in the locating holes without difficulty and guarantees that it is not tilted when pressed in.

From a diameter of 19 mm upwards, all pillars are provided with an M8 x 20 female thread for securing the Z 4327 holder for a ball retainer.

Installation in locating hole, page 4.78 (tolerance sheet).

For assembly we recommend application of Z 9060 solid lubricant in order to prevent cold setting.

Applications:

For all types of die sets, as well as in machine construction, construction of jigs and fixtures and apparatus engineering.

### Z 4321

Guide pillars DIN 9825-4 with collar  
Material 1.1213

Surface hardness  $63 \pm 2$  HRC

Induction-hardened

These pillars can be demounted quickly and easily, thus making it easier to regrind the tools.

For fixing SN 1707 retaining plates or Z 4325 fixing devices can be used either.

Installation in locating hole, page 4.78 (tolerance sheet).

From a diameter of 19 mm upwards, all pillars are provided with an M8 x 20 female thread for securing the Z 4327 holder for a ball retainer. For assembly we recommend application of Z 9060 solid lubricant in order to prevent cold welding.

Applications:

For all types of press tools requiring rapid assembly or disassembly of the pillars.

### Z 4322 light line

Guide pillars DIN 9825-4 with collar like model SN 4321 however without a top end thread. Diameter tolerance of the sliding surface h4 without finishing ( $R_z = 4$ ). Are only suited for utilisation with guide bushes.

### Z 4411 / SN 1766

Guide bushes, bronze plated

Z 4411 ~ DIN 9831 / ISO 9448.

This special bronze has an excellent thermal conductivity ensuring that friction of heat can be dissipated rapidly. This largely excludes the risk of cold welding, even in the presence of severe friction between pillars and bushes. The bronze coat (thickness approx. 0.1 mm) is galvanically deposited on the hardened steel body which in turn prevents the bushing from being deformed under high edge pressure. It therefore ensures high sliding speeds, a long service life, extremely accurate guidance if the oil supply is guaranteed. All bronzeplated guide bushes are provided with a lubricating nipple, connecting thread M8 x 1 / short version M6.

The guide bushes should be connected to the central machine lubrication system after removing the lubricating nipple for use in high-speed automatic punching machines.

Installation in locating hole size H5.

Solid lubricant Z 9060 should be applied to the installation diameter prior to assembly. All bushes of series Z 44 . . and SN 4190 have a uniform outside diameter for each pair of guide diameters and are therefore interchangeable.

### Z 4412 / SN 1769

Guide bushes, surface of sintered bronze with solid lubricant maintenance-free

Z 4412 ~ DIN 9831 / ISO 9448

Molybdenum disulphide is uniformly and finely dispersed in this sintered bronze as solid lubricant. In this way, the material combines the excellent sliding properties of a sintered bronze and the good lubricating properties of  $MoS_2$ .

A firmly adhering, highly cohesive lubricant film is formed between the guide pillar and the bushes as a result of the sliding motion, thus preventing the guide elements from seizing up even at rest and when the machine tool starts up.

The sintered bronze is encased in a steel sheath dimensioned in accordance with ~ DIN 9831 / ISO 9448 (Z 4412). This bush is ideal wherever

- liquid lubricants would leave unacceptable residues (e. g. food processing or packaging, textiles and papermaking machines).

Installation in the locating hole, size H5.

Solid lubricant Z 9060 should be applied to the installation diameter prior to assembly.

Maximum sliding speed 30 - 60 m/min.

### SN 4190

Low-maintenance guide bushes of bronze, with solid lubricant.

They are especially suitable for use under high loads, at sliding speeds  $< 0.5$  m/s and at bearing points where access is difficult. The solid-lubricant inserts are arranged in such a way that there is an overlap in the sliding direction.

The solid-lubricant inserts guarantee a uniform lubricating film between pillar and bush.

The lubricating film prevents metallic contact and counteracts corrosion. The guide bushes are designed for linear and rotary sliding directions.

Temperature range - 50 / + 150° C (take self-heating into account).

Hardness difference between bush and pillar  $> 150$  HB.

The greater running clearance is to be taken into account, especially in the case of rotary motion.

These bushes can be combined with the following pillars: SN 1705, SN 4321, Z 4310, Z 4315, Z 4318, Z 4320, Z 4330.

### Z 4415 / SN 1778

Antifriction slideway bushes

Z 4415 ~ DIN 9831 / ISO 9448 with ball retainers

SN 1799 made of brass. These bushes meet the most stringent demands as regards smooth running, service life and minimum maintenance. They are primarily used in high-speed short-stroke presses operating at more than 400 strokes per minute.

Load absorption perpendicular to the direction of movement depends on the ball diameter, the number of balls engaged and the preload. Since the service life and smooth running decrease as the preload increases, lateral forces can only be absorbed and influenced via the guide length. This means that the ball retainer should engage over its full length in the bottom limit position, since this is where the highest loads are to be expected. Solid lubricant Z 9060 should be applied to the installation diameter prior to assembly.

### Z 4425

As Z 4415 but with two additional stop rings to limit the stroke length for ball retainer SN 1798.

Preferably used in die sets without stripper plate.

### SN 1798

Ball retainer (brass)

The individual balls are offset in a ring, thus ensuring that each ball runs in its own race. The balls are made of high-strength, hardened special steel of quality class 1, grade 0 DIN 5401.

All ball retainers SN 1798 and SN 1799 are fitted with a larger number of balls making them less sensitive to lateral forces.

### SN 1799

As SN 1798 but with an additional Seeger circlip ring to prevent the retainer from "migrating".

## Information english

### Classification of pairs – Guide pillars with slideways

#### Die clearance:

The die clearance largely depends on the requirements imposed by the metal workpiece e.g. proportion of smooth zone to fracture zone and permissible burr height. The material properties of the workpiece and the type and condition of the machine used have also influence.

#### Criteria for selecting the play:

Die clearance; material thickness; type and condition of the machine used.

Die clearance		
small	Workpieces with close tolerances and certain properties of the cut contours; also thin materials.	Class 1
medium	Workpieces made of sheet metal thickness more than 1 mm, preferably for follow-on composite tools.	Class 2
large	Less stringent requirements with regard to edge definition; cutting pressure and cutting work are distinctly lower when working with a large die clearance than when working with a small or medium die clearance.	Class 3

Play	Guide pillar	Guide bushes
Class 1	A	A
Class 2	A	B
Class 3	A	C

Class 2 = Standard

4

Guide pillar $\mu\text{m}$		Total play $\mu\text{m}$	Guide bushes $\mu\text{m}$																												
Ø 15/16	A	4 - 9	A																										Ø 15/16		
		7 - 14		B																											
		12 - 19			C																										
Ø 19/20	A	4 - 11	A																										Ø 19/20		
		9 - 16		B																											
		14 - 22			C																										
Ø 24/25	A	5 - 12	A																										Ø 24/25		
		10 - 18		B																											
		16 - 25			C																										
Ø 30/32	A	5 - 12	A																										Ø 30/32		
		10 - 19		B																											
		17 - 28			C																										
Ø 38/40	A	5 - 13	A																										Ø 38/40		
		11 - 21		B																											
		19 - 32			C																										
Ø 48/50	A	6 - 14		A																										Ø 48/50	
		12 - 23			B																										
		21 - 35				C																									
Ø 60/63	A	6 - 14		A																										Ø 60/63	
		12 - 24			B																										
		22 - 36				C																									
Ø 80	A	7 - 13			A																										Ø 80
		13 - 23				B																									
		23 - 36					C																								
				-3	-2	-1	±0	4	6	8	10	12	14	16	18	20	22	24	26	28	30	32	34								

The following combinations are supplied for unspecified orders:

		Guide pillar	Guide bushes
Guide pillars	SN 1705 - Z 4330	A	
Guide bushes / Guide bearings	SN 1769 - Z 4411	A	B
Steel die sets, two-pillar version		A	B
Steel die sets, four-pillar version		A	B - C

## Information français

Toutes les bagues de guidage sont pourvus d'un signe de tolérance « A/B/C » permettant le choix optimal du jeu de coupe total nécessaire

Critères pour la sélection du jeu de guidage:

- jeu de coupe
- épaisseur de matière
- type et condition de la machine utilisée

(voir classification des appariements, page 4.77).

### Z 4310

Colonnes de guidage ~ DIN 9825 montage à la presse  
Matériau 1.1213

Dureté de surface 63 ± 2 HRC  
trempé par induction

La surface de guidage des colonnes est finement rectifiée et finie.

Le dégagement de diamètre, sur une hauteur de 7 mm permet l'installation facile des colonnes dans leurs alésages et empêche tout mauvais alignement pendant le montage à la presse.

A partir de 19 mm de diamètre, toutes les colonnes sont pourvues d'un filetage intérieur M8 x 20 pour la fixation d'une rondelle de retenue de cage Z 4327.

Montage dans l'alésage ajustement voir page 4.78 (feuille de tolérance).

Pour le montage, nous recommandons d'utiliser le lubrifiant solide Z 9060 afin d'éviter tout soudage à froid.

Domaines d'utilisation:

Pour tous les blocs à colonnes et dans la construction mécanique, la construction de gabarits et d'appareils.

### Z 4321

Colonnes de guidage DIN 9825-4 avec épaulement  
Matériau 1.1213

Dureté de surface 63 ± 2 HRC  
trempé par induction

Elles sont faciles et rapides à démonter, ce qui facilite le réaffutage des outils.

Pour la fixation, on utilisera au choix les rondelles SN 1707 ou les brides Z 4325.

Montage dans l'alésage ajustement voir page 4.78 (feuille de tolérance).

A partir de 19 mm de diamètre, toutes les colonnes sont pourvues d'un filetage intérieur M8 x 20 pour la fixation d'une rondelle de retenue de cage Z 4327.

Pour le montage nous recommandons l'utilisation d'un lubrifiant solide Z 9060 pour éviter un soudage à froid.

Domaine d'application:

Pour tous les outils de découpage nécessitant un montage ou démontage rapide des colonnes.

### Z 4322 light line

Colonnes de guidage DIN 9825-4 avec collerette comme modèle SN 4321, cependant sans filet de tête. Tolérance de diamètre de la surface de roulement h4 sans finissage (Rz = 4). Seulement appropriées pour l'utilisation avec des bagues pour guidage lisse.

### Z 4411 / SN 1766

Bagues de guidage à revêtement de bronze  
Z 4411 ~ DIN 9831/ISO 9448.

Ce bronze spécial possède une bonne conductivité thermique permettant d'éliminer rapidement la chaleur résultant de la friction. Même en cas de forte friction entre la colonne et la bague, tout soudage à froid est ainsi évité. La couche de bronze (d'une épaisseur d'environ 0,1 mm) est appliquée par galvanisation sur un corps en acier trempé, ce qui empêche aussi toute déformation de la bague de guidage même en cas de forte pression sur les génératrices. Lorsque le graissage est effectué de manière adéquate, cette couche de bronze garantit donc un glissement optimal, une grande longévité, un guidage de grande précision. Toutes les bagues de guidage à revêtement de bronze sont pourvues d'un raccord fileté de graissage, pas de raccordement M 8 x 1/ version courte, M6.

S'agissant d'outils de découpe travaillant très vite, après avoir enlevé le raccord fileté de graissage, il est recommandé de les raccorder au graissage central des machines.

Montage dans l'alésage, Ajustement H5.

Avant le montage, il est recommandé de mettre du lubrifiant solide Z 9060 sur le diamètre de montage. Toutes les bagues de guidage de la série Z 44... et SN 4190 sont pourvus par paire de diamètre de guidage d'un diamètre extérieur uniforme et sont donc interchangeable.

### Z 4412 / SN 1769

Bagues de guidage à lubrifiant solide sans entretien en bronze fritté  
Z 4412 ~ DIN 9831/ISO 9448

Ce bronze fritté contient, en une répartition uniforme et fine, un lubrifiant solide, le sulfure de molybdène. Ce produit allie les bonnes capacités de glissement d'un bronze fritté à l'exceptionnelle lubrification du MoS<sub>2</sub>.

Lors des mouvements de glissement, il se produit entre la colonne et la bague de guidage une pellicule lubrifiante fixe et bien cohérente empêchant tout grippage des éléments coulissants de l'outil, même au moment du démarrage.

Le bronze fritté est entouré d'un corps en acier dont les dimensions sont conformes à la DIN 9831/ISO 9448 (Z 4412). Cette bague peut être utilisée:

- lorsque les lubrifiants liquides laisseraient des résidus inacceptables (traitement des denrées alimentaires/emballages, industrie textiles et construction mécanique).

Montage dans l'alésage ajustement H5.

Avant le montage, il est recommandé de mettre du lubrifiant solide Z 9060 sur le diamètre de montage. Vitesse de glissement max. comprise entre 30 et 60 m/min.

### SN 4190

Bagues en bronze d'aluminium avec inserts autolubrifiants pour guidage lisse.

Ces bagues en alliage CuZn25Al5 conviennent particulièrement pour des charges élevées à vitesses de glissement < 0,5 m/s ainsi que pour les guidages d'accès difficile. Les inserts autolubrifiants sont disposés de manière à assurer un recouvrement dans le sens du glissement.

Ils produisent un film lubrifiant homogène entre colonne et bague qui empêche le contact intermétallique et prévient le grippage. Les bagues sont prévues pour glissement linéaire et rotatoire.

Températures limites - 50° C / + 150° C (tenir compte de l'échauffement propre).

Différence de dureté entre bague et colonne > 150 HB.

Tenir compte du jeu de glissement plus important, notamment en cas de mouvement circulaire.

Ces bagues peuvent être combinées avec les colonnes suivantes: SN 1705, SN 4321, Z 4310, Z 4315, Z 4318, Z 4320, Z 4330.

### Z 4415 / SN 1778

Les bagues de guidage à billes Z 4415 ~ DIN 9831/ISO 9448 - avec cage à billes en laiton SN 1799 remplissent les exigences les plus extrêmes en matière de souplesse, de longévité et de facilité d'entretien et sont essentiellement utilisées pour des presses rapides à faibles course, à partir de 400 courses/min.

Le soutien vertical de la charge par rapport au sens du mouvement dépend du diamètre des billes, du nombre de billes (porteuses) en contact et de la précontrainte (jeu de coupe négatif). L'accroissement de la précontrainte entraînant une diminution de la longévité et de la souplesse, les forces latérales ne peuvent être captées et influencées que par la longueur de guidage. En position de course basse, où l'on doit s'attendre à trouver la contrainte maximale, la cage à billes devrait être en contact (porteur) sur toute sa longueur. Avant le montage, il est recommandé de mettre du lubrifiant solide Z 9060 sur le diamètre de montage.

### Z 4425

Idem Z 4415, mais avec 2 clips de retenue supplémentaires chargés de limiter la course de la cage à billes SN 1798. Utilisé de préférence pour les outils à 2 plaques.

### SN 1798

Cage à billes en laiton. Les diverses billes sont disposées en forme d'anneau et décalées, de sorte que chacune d'entre elles se déplace sur sa propre voie. Les billes sont en acier spécial trempé haute résistance et sont conformes à la classe de qualité 1, Calibrage 0 DIN 5401.

Toutes les cages à billes SN 1798 et SN 1799 sont pourvues d'un nombre élevé de billes et de la sorte insensibles aux forces latérales.

### SN 1799

Idem SN 1798, mais avec un clip de retenue empêchant toute « promenade » de la cage.



Toleranzblatt

Tolerance sheet

Folio de tolerance

4

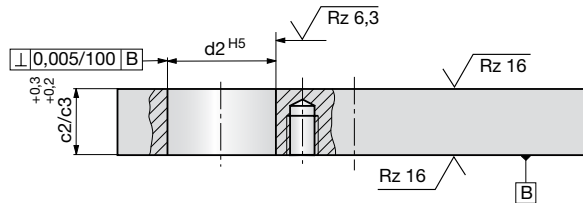
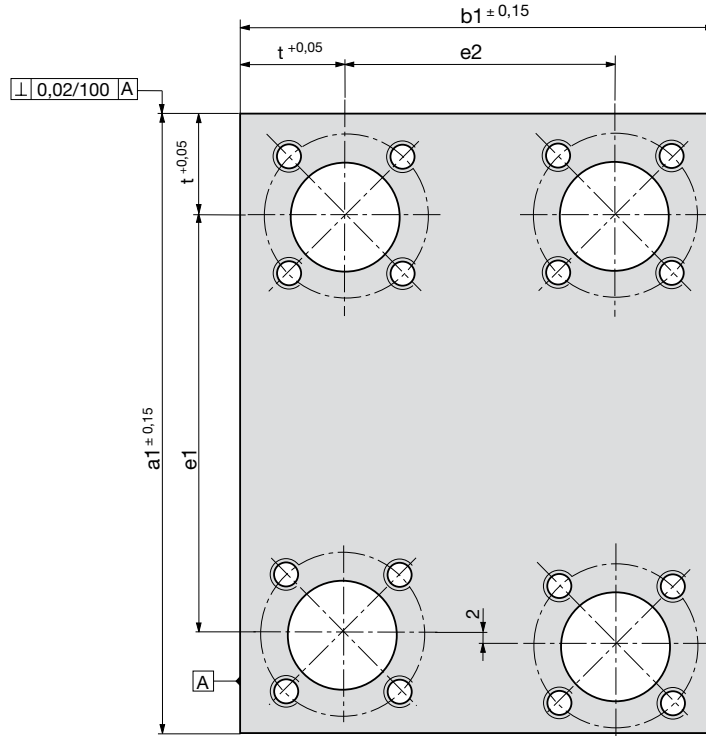

$$\sqrt{Rz\ 25} \left( \sqrt{Rz\ 16} \sqrt{Rz\ 6,3} \right)$$

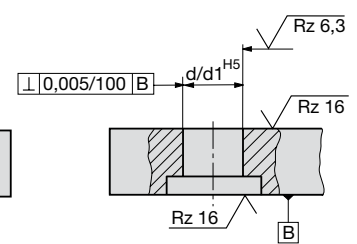
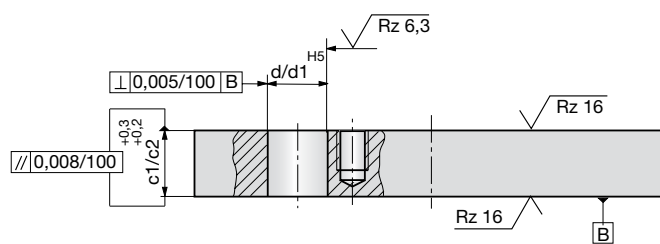
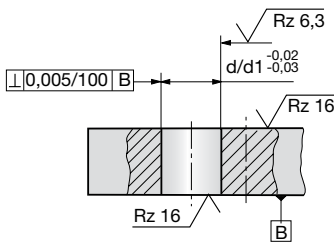

a1 / b1	Standard	Standard	Koordinatenschleifen / Jig grinding Rectification en coordonnés
	e1 / e2 St	e1 / e2 Al	e1 / e2 ST
< 200	± 0,009	± 0,015	± 0,002
≥ 200 - 500	± 0,009	± 0,02	± 0,002
≥ 500 - 700	± 0,015	± 0,02	± 0,003
≥ 700 - 1000	± 0,015	± 0,025	± 0,004
≥ 1000 - 1300	± 0,02	± 0,025	± 0,005
≥ 1300 - 3000	± 0,02	± 0,025	